



微信公众平台：海利普变频器



HLP-NV Series Instruction





HLP-NV Series

I. Introduction	2
1. Checks upon Delivery	3
2. Nameplate Description of HLP-NV Series Inverter	3
II. Safety Precautions	5
1. Before the Power-up	5
2. During the Power-up	6
3. During the Operation	6
4. After the Power-off	7
III. Standards and Specifications	8
1. Particular Specifications	8
2. General Specifications	9
IV. Storage and Installation	11
1. Storage	11
2. Installation Site and Environment	11
3. Installation and Direction	11
V. Wiring	12
1. Main Circuit Wiring Schematic Diagram	12
2. Description of Terminal Block	13
3. Basic Connection Diagram	15
4. Switches	15
5. Precautions on Wiring	16
VI. Instruction of the LCP Digital Operator	19
1. Description of the LCP Digital Operator	19
2. Programming with LCP	19
VII. Parameter Overview	25
VIII. Parameter Descriptions	37
IX. Maintenance, Fault Information and Troubleshooting	90
1. Precautions about Inspection and Maintenance	90
2. Periodical Inspection and Maintenance items	90
3. Fault Indication and Troubleshooting	91
3. Fault code description and Analysis	92



IX. Appendices	96
Appendix 1: Mounting Dimensions of HOLIP NV inverters	96
Appendix 2: Mounting Dimensions of LCP Digital operator	98
Appendix 3. Braking Resistor Disposition	98
Appendix 4. Simple Example of Appliacion	99
Appendix 5:User's feedback	106

I. Introduction

Thank you for purchasing and using the general-purpose inverter of HLP-NV series of multi-functions and high performance.

Please read carefully the operation manual before putting the inverter to use so as to correctly install and operate the inverter, give full play to its functions and ensure the safety. Please keep the operation manual handy for future reference, maintenance, inspection and repair.

Due to the inverter of a kind of electrical and electronic product it must be installed, tested and adjusted with parameters by specialized engineering persons of motors.

The marks of  **Danger**  **Caution** and other symbols in the manual remind you of the safety and prevention cautions during the handling, installation, running and inspection. Please follow these instructions to make sure the safe use of the inverter. In case of any doubt please contact our local agent for consultation. Our professional persons are willing and ready to serve you.

The manual is subject to change without notice.

 **Danger** indicates wrong use may kill or injure people.

 **Caution** indicates wrong use may damage the inverter or mechanical system.

Danger

- Be sure to turn off the input power supply before wiring.
- Do not touch any internal electrical circuit or component when the charging lamp is still on after the AC power supply is disconnected, which means the inverter still has high voltage inside and it is very dangerous.
- Do not check components and signals on the circuit boards during the operation.
- Do not disassemble or modify any internal connecting cord, wiring or component of the inverter by yourself.
- Be sure to make correct ground connection of the earth terminal of the inverter.
- Never remodel it or exchange control boards and components by yourself. It may expose you to an electrical shock or explosion, etc.

 **Caution**

- Motor overload protection is included in the default settings. Parameter C01.90 Motor thermal protection is set to value ETR trip.
- Do not make any voltage-withstanding test with any component inside the inverter. These semi-conductor parts are subject to the damage of high voltage.
- Never connect the AC main circuit power supply to the output terminals U.V W of the inverter.
- The main electric circuit boards of CMOS and IC of the inverter are subject to the effect and damage of static electricity. Don't touch the main circuit boards.
- Installation, testing and maintenance must be performed by qualified professional personnel.
- The inverter should be discarded as industrial waste. It is forbidden to burn it.

1. Checks upon Delivery

The inverter has been strictly and well packed before ex-work. In consideration of various factors during the transportation special attention should be paid to the following points before the assembly and installation. If there is anything abnormal please notify the dealer or the relevant people of our company.

- Check if the inverter has got any damage or deformation during the transportation and handling.
- Check if there is one piece of HLP-NV series inverter and one copy of the instruction manual available when unpacking it.
- Check the information on the nameplate to see if the specifications meet your order (Operating voltage and KVA value).
- Check if there is something wrong with the inner parts, wiring and circuit board.
- Check if each terminal is tightly locked and if there is any foreign article inside the inverter.
- Check if the operator buttons are all right.
- Check if the optional components you ordered are contained.
- Check if there is a certificate of qualification and a warranty card.

2. Nameplate Description of HLP-NV Series Inverter

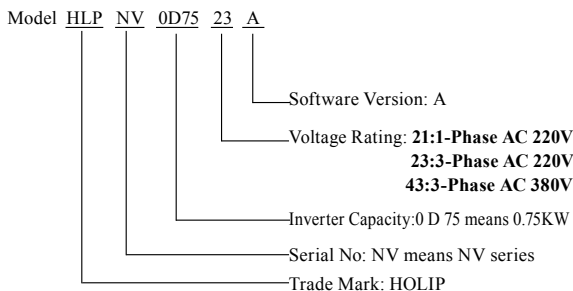

II. Safety Precautions

1. Before the Power-up

Caution

- Check to be sure that the voltage of the main circuit AC power supply matches the input voltage of the inverter.
- The symbol  , represents ground terminals. Be sure to make correct ground connection of the earth terminals of the motor and the inverter for safety.
- No contactor should be installed between the power supply and the inverter to be used for starting or stopping of the inverter. Otherwise it will affect the service life of the inverter.

Danger

- R(L),S,T(N) terminals are power input terminals, never mixed with U,V,W terminals. Be sure that the wiring of the main circuit is correct. Otherwise it will cause damages of the inverter when the power is applied to it.
- The terminal of  must be grounded separately and never connected to line zero. Otherwise it will easily cause the protection or errors of the inverter.

Caution

- Do not carry the front cover of the inverter directly when handling. It should be handled with the base to prevent the fall-off of the front cover and avoid the dropping of the inverter, which may possibly cause the injuries to people and the damages to the inverter.
- Mount the inverter on a metal or other noncombustible material to avoid the risk of fire.
- Install the inverter in a safe location, avoiding high temperature, direct sunlight, humid air or water.
- Keep the inverter from the reach of children or persons not concerned.
- The inverter can only be used at the places accredited by our company. Any unauthorized working environment may have the risks of fire, gas explosion, electric shock and other incidents.
- Install a heat sink or other cooling device when installing more than one inverter in the same enclosure so that the temperature inside the enclosure be kept below 40°C to avoid overheat or the risk of fire.

- Be sure to turn off the power supply before disassembling or assembling the operation keypanel and fixing the front cover to avoid bad contact causing faults or non-display of the operator.
- Do not install the inverter in a space with explosive gas to avoid the risk of explosion.
- If the inverter is used at or above 1000m above seal level, the cooling efficiency will be worse, so please run it by de-rating.
- Do not install any contactor and other components of capacitor or varistor on the output side of the inverter. Otherwise it will cause malfunctions and damages of components of the inverter.
- Do not install any switch component like air circuit breaker or contactor at the output of the inverter. If any of such components must be installed because of the requirements of process and others, it must be ensured that the inverter has no output when the switch acts. In addition, it is forbidden to install any capacitor for improvement of power factor or any varistor against thunder at the output. Otherwise it will cause malfunctions, tripping protection and damages of components of the inverter. Please remove them as shown in the below diagram.
- It will affect the service life of the inverter if a contact is connected to the front end of input of the inverter to control its starts and stops. Generally it is required to control it through Control terminals. Special attention should be paid to its use in the case of frequent starts and stops.
- Please use an independent power supply for the inverter. Do avoid using the common power supply with an electrical welder and other equipment with strong disturbance. Otherwise it will cause the protection or even damage of the inverter.

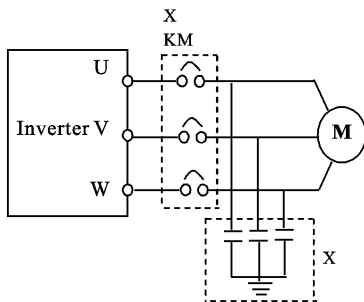

2. During the Power-up

Danger

- Do not plug the connectors of the inverter during the power up to avoid any surge into the main control board due to plugging, which might cause the damage of the inverter.
- Always have the protective cover in place before the power up to avoid electrical shock injury.

3. During the Operation

Danger

- Never connect or disconnect the motor set while the inverter is in running. Otherwise it will cause over-current trip and even burn up the main circuit of the inverter.
- Never remove the front cover of the inverter while the inverter is powered up to avoid any injury of electric shock.
- Do not come close to the machine when the fault restart function is used to avoid anything unexpected. The motor may automatically restart after its stop.
- The function of STOP Switch is only valid after setting, which is different with the use of emergent stop switch. Please pay attention to it when using it.

Caution

- Do not touch the heat sink, braking resistor, or other heat elements. These can become very hot.
- Be sure that the motor and machine is within the applicable speed ranges before starting operation because the inverter is quite easy to run from lower speed to higher speed.
- Do not check the signals on circuit boards while the inverter is running to avoid danger.
- Be careful when changing the inverter settings. The inverter has been adjusted and set before ex-work. Do not adjust it wantonly. Please make proper adjustments according to the required functions.
- Do consider the vibration, noise and the speed limit of the motor bearings and the mechanical devices when the inverter is running at or above the frequency of 50Hz.

4. After the Power-off

- Touching the electrical parts may be fatal - even after the equipment has been disconnected from mains. Also make sure that other voltage inputs have been disconnected, (linkage of DC intermediate circuit).
- Be aware that there may be high voltage on the DC link even when the LEDs are turned off.
- Before touching any potentially live parts of the VLT Micro, wait at least as follows:
200 - 240 V, 0.4 – 1.5 kW: wait at least 4 minutes.
380 - 480 V, 0.75 – 2.2 kW: wait at least 4 minutes.
Shorter time is allowed only if indicated on the nameplate for the specific unit.

The user must strictly follow the instruction to operate and make wire connection. Otherwise HOLIP will not responsible for the damages due to wrong operation. The user will responsible for the damages themselves.

III. Standards and Specifications

1. Particular Specifications

Model	Input Voltage	Power (KW)	Output Current (A)	Suitable Motor (KW)
HLPNV0D1821A	1×200-240V 50/60Hz	0.18	1.2	0.18
HLPNV0D3721A	1×200-240V 50/60Hz	0.37	2.2	0.37
HLPNV0D7521A	1×200-240V 50/60Hz	0.75	4.2	0.75
HLPNV01D521A	1×200-240V 50/60Hz	1.5	6.8	1.5
HLPNV02D221A	1×200-240V 50/60Hz	2.2	9.6	2.2
HLPNV0D2523A	3×200-240V 50/60Hz	0.25	1.5	0.25
HLPNV0D3723A	3×200-240V 50/60Hz	0.37	2.2	0.37
HLPNV0D7523A	3×200-240V 50/60Hz	0.75	4.2	0.75
HLPNV01D523A	3×200-240V 50/60Hz	1.5	6.8	1.5
HLPNV02D223A	3×200-240V 50/60Hz	2.2	9.6	2.2
HLPNV03D723A	3×200-240V 50/60Hz	3.7	15.2	3.7
HLPNV0D3743A	3×380-480V 50/60Hz	0.37	1.2	0.37
HLPNV0D7543A	3×380-480V 50/60Hz	0.75	2.2	0.75
HLPNV01D543A	3×380-480V 50/60Hz	1.5	3.7	1.5
HLPNV02D243A	3×380-480V 50/60Hz	2.2	5.3	2.2
HLPNV03D043A	3×380-480V 50/60Hz	3.0	7.2	3.0
HLPNV04D043A	3×380-480V 50/60Hz	4.0	9.0	4.0
HLPNV05D543A	3×380-480V 50/60Hz	5.5	12	5.5
HLPNV07D543A	3×380-480V 50/60Hz	7.5	15.5	7.5
HLPNV001143A	3×380-480V 50/60Hz	11	23.0	11
HLPNV001543A	3×380-480V 50/60Hz	15	31.0	15
HLPNV18D543A	3×380-480V 50/60Hz	18.5	37.0	18.5
HLPNV002243A	3×380-480V 50/60Hz	22	43.0	22

2. General Specifications

Inverter Series		HLP-NV		
Power supply	Frequency	48~62HZ		
	Supply Voltage	380~480V±10% for 380V; single/three phase 200~240V±10% for 220V		
Motor output	Output voltage	0~100% of supply voltage		
	Output frequency	0-200HZ(VVC+), 0-400HZ(V/F)		
	Over load	150% of rated current		
	Acc/Dec time	0.05~3600s		
Control	Running control	LCP operate; Multi input terminals;		
	Frequency setting	RS 485 serial communication		
Control terminals	Programmable digital inputs	Number	5, terminal nos.: RUN, F/R,RST,JOG,EMS	
		Voltage level	0~24V DC (“PNP” OR “NPN”); Maximum input: 28V DC	
		Logic Voltage level	PNP: “0”<5VDC; “1”>10VDC;	
			NPN: “0”>19VDC; “1” <14VDC	
	Input resistance	4KΩ		
	Anology inputs	Voltage	Number	1;terminal nos.: VIN
			Voltage level	0-10V DC ; Maximum input 20V DC
			Input resistance	10KΩ
		Current	Number	2; terminal nos.: VIN,AIN
			Current range	0/4-20mA(scaleable); Maximum input: 30mA
			Input resistance	200 Ω
	Anology outputs	Number	1;Terminal nos.: AO	
		Output Current range	0/4-20mA	
		Max.Load	500 Ω	
Accuracy		Max.error:0.5% of full scale		
Resolution		8bit		

Control terminals	24V DC	Terminal number		EV
		Max.load		200mA
	RS 485	Terminal number		RS+(TX+,RX+), RS- (TX-,RX-)
		Ground for RS485		COM
	Realy outpus	Terminal number		1,FA-FB(make), FA-FC(break)
		Max load	Resistive load	250V AC 2A 30V DC 2A
			Inductive load	250V AC 0.2A 24V DC 0.1A
		10V DC output	Terminal number	
	Output voltage		10.5±0.5V	
	Max.load		25mA	
Surro-undings	Enclosure			IP20
	Ambient temperature			-10°C~50°C
	Max.relative humidity			5%-95%
	Vibration test			1.0g
	Max.altitude above sea level			1000m 3000m(derating)
Protection Functions	Electronic thermal motor protection against overload.			
	Temperature monitoring of the heatsink ensures that the frequency converter trips if the temperature reaches 95 °C ± 5°C. An overload temperature cannot be reset until the temperature of the heatsink is below 70 °C ± 5°C (Guideline - these temperatures may vary for different power sizes, enclosures etc.).			
	The frequency converter is protected against short-circuits on motor terminals U, V, W.			
	The frequency converter is protected against earth faults on motor terminals U, V, W.			
	Monitoring of the intermediate circuit voltage ensures that the frequency converter trips if the intermediate circuit voltage is too low or too high.			
	If a motor phase is missing, the frequency converter may trip.			
	If mains fault occurs, the frequency converter will ramp down to stop and issues a warning.			
	If a mains phase is missing, the frequency converter trips or issues a warning (depending on the load).			

IV. Storage and Installation

1. Storage

The inverter must be kept in its original package box before installation. Pay attention to the followings when keeping it in storage if the inverter is not used for the time being:

- It must be stored in a dry place without rubbish or dust.
- The suitable temperature for storage is between -20°C and +65°C.
- The relative humidity required is 0-95% without condensation.
- There is no corrosive gas or liquid in the storage ambience.
- It's better to lay the inverter on a rack and keep it in a proper package.
- It is better not to store the inverter for long time. Long time storage of the inverter will lead to the deterioration of electrolytic capacity. If it needs to be stored for a long time make sure to power it up one time within a year and the power-up time should be at least above five hours. When powered up the voltage must be increased slowly with a voltage regulator to the rated voltage value.

2. Installation Site and Environment

The inverter should be installed at the following location:

- Ambient temperature -5°C to 40°C with good ventilation.
- No water drop and low moisture.
- Free from direct sunshine, high temperature and heavy dust fall.
- Free from corrosive gas or liquid.
- Less dust, oil gas and metallic particles
- Free from vibration and easy for service and inspection.
- Free from the interference of electromagnetic noise.

Attention: The ambient conditions of the inverter will affect its service life.

3. Installation and Direction

- There must be enough space left around the inverter for easy maintenance and cooling.
- The inverter must be installed vertically with the smooth ventilation

for effective cooling.

- If there is any instability when installing the inverter, please put a flat board under the inverter bottom base and install it again. If the inverter is installed on a loose surface, stress may cause damage of parts in the main circuit so as to damage the inverter.
- The inverter should be installed on non-combustible materials, such as iron plate.
- If several inverters are installed, upper and lower, together in one cabinet, please add heat dissipation plates and leave enough space between the inverters.

V. Wiring

1. Main Circuit Wiring Schematic Diagram



Power supply:

- Verify that the inverter's rated voltage coincides with AC power supply voltage to avoid a damage of the inverter.



No fuse breaker:

- Refer to the related list.

Ground fault circuit interrupter:

- Use one of anti-high harmonic.



Electromagnetic contactor:

- Note: Do not use the electromagnetic contactor as the on/off button of power supply for the inverter.



AC reactor:

- It is recommended to install an AC reactor for power factor improvement if the input capacity is more than 1000KVA.



Inverter:

- Be sure to make correct connections of the main circuit wires and control signal wires of the inverter.
- Be sure to make correct setting of parameters for the inverter.



2. Description of Terminal Block

1) Arrangement of Main circuit Terminals

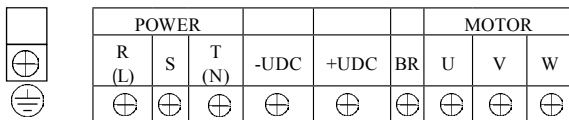

Function Description of Main circuit Terminals

Symbol	Function Description
R S T	Input terminal of AC line power. (220V class:for both single/three phase, single phase connected to L and N)
U.V.W	Output terminal of the inverter
+UDC BR	Connector for braking resistor (optional).
-UDC	Connector for DC reactor
⊕	Ground terminal: the third method of grounding for 220V and special grounding for 380 V of Electrical Engineering Regulations.

2) Arrangement of Control Circuit Terminals

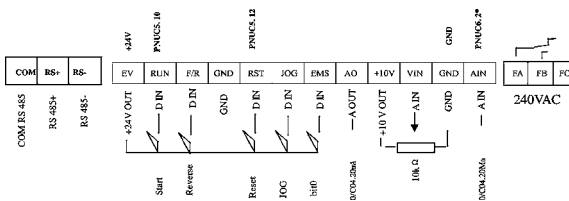

Function Description of Control Circuit Terminals

Symbol	Function Description	Default setting setting
EV	Common Terminal of Digital and Control Signals (+24V Power)	
RUN	Multi- Digital Input	Start
F/R	Multi- Digital Input	Reverse
GND	Digital Ground (for 24V power)	
RST	Multi- Digital Input	Reset
JOG	Multi- Digital Input	Jog

Symbol	Function Description	Default setting setting
EMS	Multi- Digital Input	Bit0
AO	Multi- Analog Output	0/4~20mA
+10V	Power Supply for Analog Setting	+10V
VIN	Multi- Analog input	Voltage
GND	Analog Ground	
AIN	Multi- Analog input	0/4~20mA
FA FB FC	Multi- Digital Output (Relay)	FA-FC:break FA-FB:make
COM RS+ RS-	RS485 Communication port	COM:Common for RS+ and RS-

3. Basic Connection Diagram

The wiring of the inverter is divided into two parts, main circuit terminal connections and control circuit terminal connections. The user can see the main circuit terminals and the control circuit terminals after removing the cover of enclosure. The terminals must be connected correctly as the following wiring circuit diagrams.

The following diagram shows the Default setting standard connection of Model HLP-NV

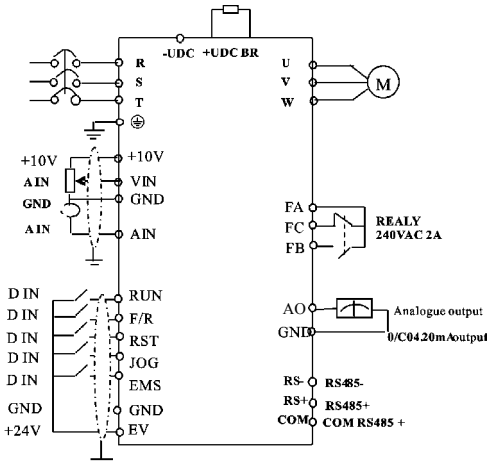

4. Switches

i. Bus termination:

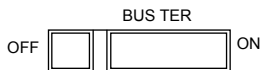

Mark: Switch BUS TER enables termination of the RS485 port, terminals RS+, RS-.

ii. Switches 1-4:

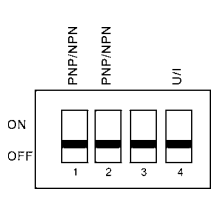

Switch 1:	*OFF = PNP terminal JOG ON = NPN terminal JOG
Switch 2:	*OFF = PNP terminals RUN, F/R,RST,EMS ON = NPN terminals RUN, F/R,RST,EMS
Switch 3:	No function
Switch 4:	*OFF = Terminal VIN 0 - 10 V ON = Terminal VIN 0/4 - 20 mA
* = default setting	

ATTENTION: Parameter C06.19 must be set according to Switch 4 position.

Warning: Do not operate switches with power on the frequency converter.

5. Precautions on Wiring

1) For the main circuit wiring:

- While wiring the sizes and specifications of wires should be selected and the wiring should be executed according to the electrical engineering regulations to ensure the safety.
- It is better to use shielded wire or wire and conduit for power cord and ground the shielded layer or two ends of wire conduit.
- Be sure to install a Non Fuse Breaker (NFB) between the power supply and the input terminals (L1.L2.L3). (If using ground fault circuit interrupter, please choose one corresponding to high frequency)
- Never connect AC power to the output terminal (U.V.W) of the inverter.
- Output wires mustn't be in touch of the metal part of the inverter enclosure, or it will result in earth short-circuit.
- Phase-shifting capacitors, LC, RC noise filters, etc, can never be connected to the output terminals of the inverter.
- The main circuit wire must be enough far away from other control equipments.

- When the wiring between the inverter and the motor exceeds 15 meters (shielded wire) or 50 meters (No shielded wire), much higher dV/dT will be produced inside the coil of the motor, which will cause the destruction to the interlay or insulation of the motor. Please use a dedicated AC motor for the inverter or add a reactor at the inverter.
- Please lower the carrier frequency when there is a longer distance between the inverter and the motor. Because the higher the carrier frequency is the bigger the leakage current of high-order harmonics in the cables will be. The leakage current will have unfavorable effect on the inverter and other equipment.

Specifications of Non Fuse Breaker and Wire

Model	NFB (A)	Input wire mm ²	Output wire mm ²	Control wire mm ²
HLPNV0D1821A	16	2.5	2.5	0.5
HLPNV0D3721A	16	2.5	2.5	0.5
HLPNV0D7521A	16	2.5	2.5	0.5
HLPNV01D521A	16	2.5	2.5	0.5
HLPNV02D221A	32	4	4	0.5
HLPNV0D2523A	16	2.5	2.5	0.5
HLPNV0D3723A	16	2.5	2.5	0.5
HLPNV0D7523A	16	2.5	2.5	0.5
HLPNV01D523A	32	2.5	2.5	0.5
HLPNV02D223A	32	4	4	0.5
HLPNV03D723A	32	4	4	0.5
HLPNV0D3743A	16	2.5	2.5	0.5
HLPNV0D7543A	16	2.5	2.5	0.5
HLPNV01D543A	16	2.5	2.5	0.5
HLPNV02D243A	16	2.5	2.5	0.5
HLPNV03D043A	16	2.5	2.5	0.5
HLPNV04D043A	32	4	4	0.5
HLPNV05D543A	32	4	4	0.5
HLPNV07D543A	40	6	6	0.5
HLPNV001143A	63	6	6	0.5
HLPNV001543A	100	6	6	0.5
HLPNV18D543A	100	10	10	0.5
HLPNV002243A	100	16	16	0.5

Attention: The parameters in the list are only for reference and should not be regarded as standard.

2) For control circuit wiring (signal line)

- The signal line should be separately laid in a different conduit with the main circuit wire to avoid any possible interference.
- Please use the shielded cable with the size of 0.5-2mm² for signal lines.
- Use the control terminals on the control panel correctly according to your needs.

3) Grounding

- Grounding terminal E. Be sure to make correct grounding
220V class: The third grounding method (Grounding resistance should be 100Ω or lower.)
380V class: The special third grounding method (Grounding resistance should be 10Ω or lower.)
- Choose grounding wires according to the basic length and size of the technical requirements of the electric equipment.
- Do avoid sharing grounding wire with other large power equipment such as electric welder, power machine, etc. The grounding wire should be kept away from the power supply wires for large power equipment.
- The grounding method for several inverters together should be done as the first and second diagrams below. Avoid the third loop.
- The grounding wire must be as short as possible.

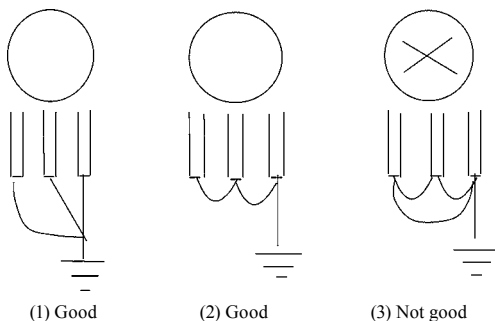

VI. Instruction of the LCP Digital Operator

1. Description of the LCP Digital Operator

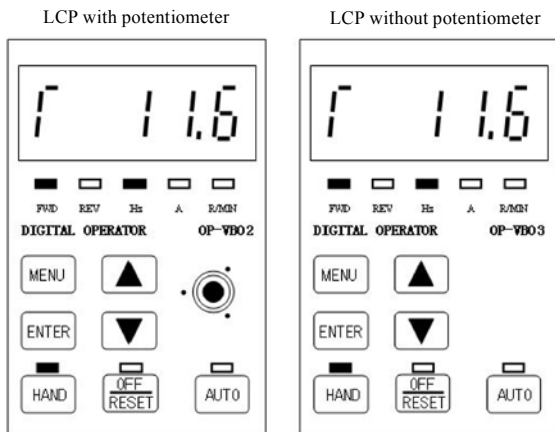

2. Programming with LCP

2.1. LCP introduction:

1. 5 numeric displays
2. 8 LEDs: FWD, REV, Hz, A, R/MIN, HAND, OFF/RESET, AUTO
3. 7 keys: MENU, ENTER, ▲, ▼, HAND, OFF/RESET, AUTO
4. 1 potentiometer (only for type OP-VB02).

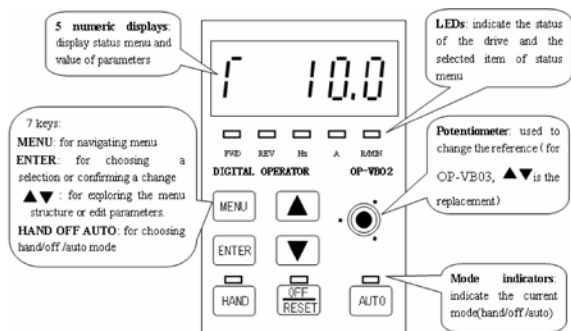

2.2. General Operation

The menu system allows operators to navigate through hierarchical menus which contain related menu items. The top-level menu contains two menu items: status menu, parameter editing menu. These two items can be explored by pressing MENU key:

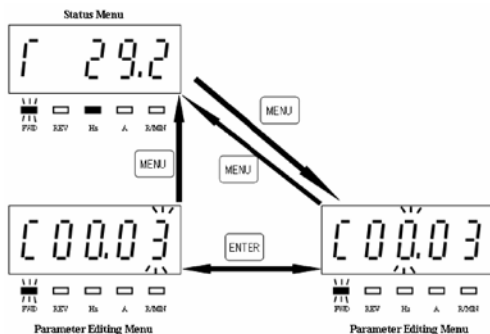

2.3. Mode keys and potentiometer

Mode Keys are used to send Hand, OFF/Reset, Auto request to the drive. It is related to the reference site selection (Local or Remote). The yellow LEDs indicate the certain active mode.



The HAND, OFF/RESET and AUTO key can be disabled by changing parameter(C00.40, C00.41, C00.42).

Potentiometer: used for setting the reference only.



The potentiometer can be used in both hand and auto mode with different functionality:

In Hand mode the potentiometer will work as the arrow keys – i.e. controlling the local reference from 0 to max reference (C03.03). If the LCP does not contain a potentiometer, the arrow keys are used to set reference:

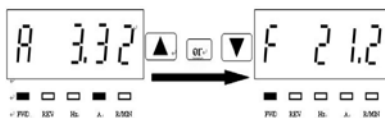

In auto mode the potentiometer will act as an extra analog input to the system. It is selected/deselected as the other analog inputs (see C03.15 to C03.18).

C06.81, C06.82 are used to scale the potentiometer input.

2.4 Parameter editing menu and status menu

2.4.1 Parameter editing menu:



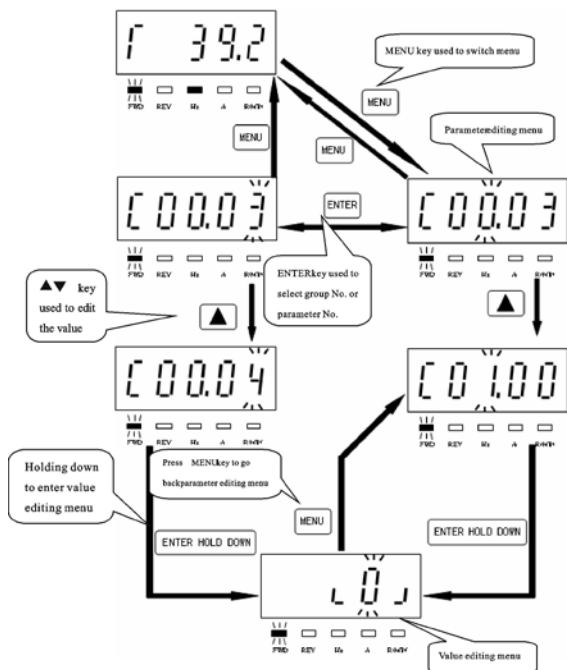

Parameter setting example:

How to set C03.17 to 21



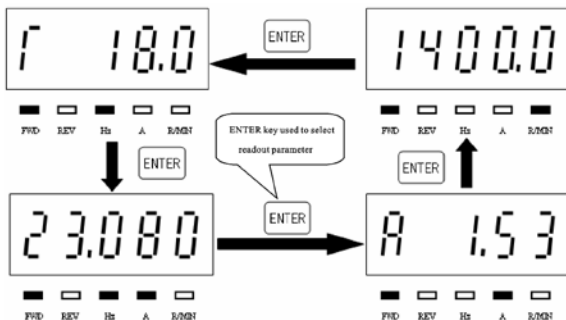

1. Pressing **MENU** key to let the display go to parameter editing menu.
2. Pressing **▲▼** key to select group No.(C03.00)
3. Pressing **ENTER** key to edit parameter No.,then pressing **▲▼** key to select parameter No. (C03.17).
4. Holding down **ENTER** key to go to the value edting menu, then pressing **▲▼** to edit the value of the parameter to 21,then holding down **ENTER** key to confirm the change till "END" was displayed.

2.4.2 Readout and indicator:

The readout parameters toggled by pressing ENTER key:



The below table shows the screen of displaying every readout parameter

no	Description	DISPLAY
1	Output Frequency → PNU = 16-13 Absolute value of output frequency is displayed Resolution: 0.1Hz Current display is 50.0Hz The LED of Hz is on and A, R/MIN are off	
2	Output Current → PNU = 16-14 Resolution: 0.01A Current display is 5.28A The LED of A is on and Hz, R/MIN are off	
3	Reference value → PNU = 16-01 Absolute value of Reference value is displayed Resolution: 0.001 Current display is 28.000 The LED of Hz, A is on and R/MIN are off	
4	Custom Readout → PNU = 16-09 Display range: 0.01 ~ 9999.99 Resolution: 0.01 Current display is 1400.0 The LED of R/MIN is on and Hz, A are off	

Warning description:

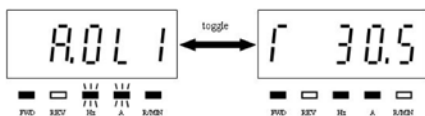







when warning occurred, the LEDs of Hz, A will flash and R/MIN will be lit.

Alarm description:



when alarm occurred, the LEDs of Hz, A and R/MIN will flash, and the drive will trip. A trip can be cancelled by pressing reset or, in some cases, automatically. A locked trip can be cancelled by cutting off mains and restarting the drive.

The motor direction is indicated by the leds of FWD and REV:

Reference	Output frequency	Indicator Display
≥ 0	STOP	
< 0	STOP	
≥ 0	≥ 0	
≥ 0	< 0	
< 0	≥ 0	
< 0	< 0	

VII. Parameter Overview

Item	Function Code	Fuction Description	Range&Function explanation	Default setting
Operation / Display	C00.04	Oper. State at Power-up [Hand]	[0] Resume *[1] Forced stop, ref = old [2] Forced stop, ref = 0	1
	C00.31	Custom Readout Min Scale	0.00 – 9999.00	0.00
	C00.32	Custom Readout Max Scale	0.00 – 9999.00	100.00
	C00.40	[Hand on] Key on LCP	[0] Disabled *[1] Enabled	1
	C00.41	[Off / Reset] Key on LCP	[0] Disable All *[1] Enable All [2] Enable Reset Only	1
	C00.42	[Auto on] Key on LCP	[0] Disabled *[1] Enabled	1
	C00.60	Menu locked	[0]Disabled [1]Enabled	0
Load / Motor	C01.00	Configuration Mode	*[0] Speed open loop [3] Process	0
	C01.01	Motor Control Principle	[0] V/F *[1] VVC+	1
	C01.03	Torque Characteristics	*[0] Constant torque [2] Automatic Energy Optim.	0
	C01.05	Local Mode Configuration	[0] Speed Open Loop *[2] As config in param. C01.00	2
	C01.20	Motor Power [kW] [HP]	0.09 kW / 0.12 HP 11 kW / 15 HP	**
	C01.22	Motor Voltage	50 - 999 V	**
	C01.23	Motor Frequency	20 - 400 Hz	50 Hz
	C01.24	Motor Current	0.01 - 26.00 A	**
	C01.25	Motor Nominal Speed	100 - 9999 rpm	**
	C01.29	Automatic Motor Tuning (AMT)	*[0] Off [2] Enable AMT	0
	C01.30	Stator Resistance (Rs)	[Ohm] * Dep. on motor data	**

Item	Function Code	Fuction Description	Range&Function explanation	Default setting
Load / Motor	C01.33	Stator Leakage Reactance (X1)	[Ohm] * Dep. on motor data	**
	C01.35	Main Reactance (X2)	[Ohm] * Dep. on motor data	**
	C01.50	Motor Magnetisation at 0 Speed	0 - 300 %	100%
	C01.52	Min Speed Norm. Magnet. [Hz]	0.0 - 10.0 Hz	0.0Hz z
	C01.55	V/F Characteristic - V	0 - 999.9 V * 0.0 V	0V
	C01.56	V/F Characteristic - F	0 - 400 Hz	0Hz z
	C01.60	Low Speed Load Compensation	0 - 199 %	100%
	C01.61	High Speed Load Compensation	0 - 199 %	100%
	C01.62	Slip Compensation	-400 - 399 %	100%
	C01.63	Slip Compensation Time Constant	0.05 - 5.00 s	0.10s
	C01.71	Start Delay	0.0 - 10.0 s	0.0S
	C01.72	Start Function	[0] DC hold / delay time [1] DC brake / delay time *[2] Coast / delay time	2
	C01.73	Flying Start	*[0] Disabled [1] Enabled	0
	C01.80	Function at Stop	*[0] Coast [1] DC hold	0
	C01.82	Min Speed for Funct. at Stop [Hz]	0.0 - 20.0 Hz	0.0Hz
	C01.90	Motor Thermal Protection	*[0] No protection [1] Termistor warning [2] Thermistor trip [3] Etr warning 1 [4] Etr trip 1	3
C01.93	Thermistor Resource	*[0] None [1] Analog Input VIN [6] Digital Input JOG	0	

Item	Function Code	Fuction Description	Range&Function explanation	Default setting
Brakes	C02.00	DC Hold Current	0 - 100 %	50%
	C02.01	DC Brake Current	0 - 100 %	50%
	C02.02	DC Braking Time	0.0 - 60.0	10.0S
	C02.04	DC Brake Cut In Speed	0.0 - 400.0 Hz	0.0Hz
	C02.10	Brake Function	*[0] Off [1] Resistor brake [2] AC brake	0
	C02.11	Brake Resistor (ohm)	5 -5000Ω	*
	C02.16	AC Brake, Max current	0 - 400 %	100%
	C02.17	Over-voltage Control	*[0] Disabled [1] Enabled (not at stop) [2] Enabled	0
	C02.20	Release Brake Current	0.00 - 100.00 A	0.00A
	C02.22	Activate Brake Speed [Hz]	0.0 - 400.0 Hz	0.0HZ
Reference / Ramps	C03.00	Reference Range	*[0] Min – Max [1] -Max - +Max	0
	C03.02	Minimum Reference	-4999.000 - 4999.000	0.000
	C03.03	Maximum Reference	-4999.000 - 4999.000	50.000
	C03.10	Preset Reference	-100.00 - 100.00 %	0.00%
	C03.11	Jog Speed [Hz]	0.0 - 400.0 Hz	5.0Hz
	C03.12	Catch up/slow Down Value	0.00-100.00%	0.00%
	C03.14	Preset Relative Reference	-100.00%~100.00%	0.00%
	C03.15	Reference Resource 1	[0] No function *[1] Analog Input VIN [2] Analog Input AIN [8] Pulse input 33 [11] Local bus ref [21] Lcp Potentiometer	1
	C03.16	Reference Resource 2	[0] No function [1] Analog Input VIN [2] Analog Input AIN	2
C03.17	Reference Resource 3	[11] Local bus ref [21] Lcp Potentiometer	11	

Item	Function Code	Fuction Description	Range&Function explanation	Default setting
Reference / Ramps	C03.18	Relative Scaling Ref. Resource	*[0] No function [1] Analog Input VIN [2] Analog Input AIN [8] Pulse input 33 [11] Local bus ref [21] Lcp Potentiometer	0
	C03.40	Ramp 1 Type	*[0] Linear [2] Sine2 ramp	0
	C03.41	Ramp 1 Ramp up Time	0.05~3600.00S	3.00/ 15.00S
	C03.42	Ramp 1 Ramp Down Time	0.05~3600.00S	3.00/ 30.00S
	C03.50	Ramp 2 Type	*[0] Linear [2] Sine 2 ramp	0
	C03.51	Ramp 2 Ramp up Time	0.05~3600.00S	3.00/ 15.00S
	C03.52	Ramp 2 Ramp down Time	0.05~3600.00S	3.00/ 30.00S
	C03.80	Jog Ramp Time	0.050~3600.000S	3.00/ 15.00S
	C03.81	Quick Stop Ramp Time	0.05~3600.00S	3.00/ 30.00S
Limits / Warnings	C04.10	Motor Speed Direction	*[0] Clockwise [1] CounterClockWise [2] Both	2
	C04.12	Motor Speed Low imit [Hz]	0.0~400.0Hz	0.0Hz
	C04.14	Motor Speed High Limit [Hz]	0.0~400.0Hz	65.0Hz
	C04.16	Torque Limit Motor Mode	0~400%	150%
	C04.17	Torque Limit Generator Mode	0~400%	100%
	C04.50	Warning Current Low	0.00~26.00A	0.00A
	C04.51	Warning Current High	0.00~100.00A	100.00A
	C04.58	Missing Motor Phase Function	[0] Off * [1] On	1
	C04.61	Bypass Speed From [Hz]	0.0~400.0Hz	0.0Hz
C04.63	Bypass Speed To [Hz]	0.0~400.0Hz	0.0Hz	

Item	Function Code	Fuction Description	Range&Function explanation	Default setting
Digital In / Out	C05.10	Terminal RUN Digital Input	[0] No function [1] Reset	8
	C05.11	Terminal F/R Digital Input	[2] Coast inverse [3] Coast and reset inv. [4] Quick stop inverse	10
	C05.12	Terminal RST Digital Input	[5] DC-brake inv. [6] Stop inv	1
	C05.13	Terminal JOG Digital Input	[8] Start [9] Latched start [10] Reversing	14
	C05.15	Terminal EMS Digital Input	[11] Start reversing [12] Enable start forward [13] Enable start reverse [14] Jog [16] Preset ref bit 0 [17] Preset ref bit 1 [18] Preset ref bit 2 [19] Freeze reference [20] Freeze output [21] Speed up [22] Speed down [23] Setup select bit 0 [26] Precise Stop Inverse (Only for C05.15) [27] Start, Precise Stop (Only for C05.15) [28] Catch up [29] Slow down [32] Pulse Input (Only for C05.15) [34] Ramp bit 0 [60] Counter A(up) [61] Counter A(down) [62] Reset counter A [63] Counter B(up) [64] Counter B(down) [65] ResetCounterB	16
	C05.40	Function Relay	*[0] No operation [1] Control ready [2] Drive ready [3] Drive ready, Remote [4] Enable / No warning [5] Drive running [6] Running / No warning [7] Run in range / No warning	

Item	Function Code	Fuction Description	Range&Function explanation	Default setting
Digital In / Out			[8] Run on ref / No warning [9] Alarm [10] Alarm or warning [12] Out of current range [13] Below current, low [14] Above current, high [21] Thermal warning [22] Ready, No thermal warning [23] Remote ready, No thermal warning [24] Ready, Voltage ok [25] Reverse [26] Bus ok [28] Brake, NoWarn [29] Brake ready / NoFault [30] BrakeFault (IGBT) [32] Mech.brake control [36] Control word bit 11 [51] Local ref. active [52] Remote ref. active [53] No alarm [54] Start cmd active [55] Running reverse [56] Drive in hand mode [57] Drive in auto mode [60] Comparator 0 [61] Comparator 1 [62] Comparator 2 [63] Comparator 3 [70] Logic rule 1 [71] Logic rule 2 [72] Logic rule 3 [80] SL digital output A [81] SL digital output B	9
	C05.55	Terminal EMS Low Frequency	20~4999Hz	20

Item	Function Code	Fuction Description	Range&Function explanation	Default setting
	C05.56	Terminal EMS High Frequency	21~5000Hz	5000
	C05.57	Term. EMS Low Ref./Feedb. Value	-4999.000~4999.000	0.000
	C05.58	Term. EMS High Ref./Feedb. Value	-4999.000~4999.000	50.000
Analog In / Out	C06.00	Live Zero Timeout Time	0~99S	10S
	C06.01	Live Zero TimeoutFunction	*[0] Off [1] Freeze output [2] Stop [3] Jogging [4] Max speed [5] Stop and trip	0
	C06.10	Terminal VIN Low Voltage	0.00~9.99V	0.07V
	C06.11	Terminal VIN High Voltage	0.10~10.00V	10.00V
	C06.12	Terminal VIN Low Current	0.00~19.99mA	0.14
	C06.13	Terminal VIN High Current	0.10~20.00mA	20.00
	C06.14	Term. VIN Low Ref./Feedb. Value	-4999.000~4999.000	0.000
	C06.15	Term. VIN High Ref./Feedb. Value	-4999.000~4999.000	50.000
	C06.16	Terminal VIN Filter Time Constant	0.01~10.00S	0.01
	C06.19	Terminal VIN mode	*[0] Voltage mode [1] Current mode	0
	C06.22	Terminal AIN Low Current	0.00~19.99mA	0.14
	C06.23	Terminal AIN High Current	0.10~20.00mA	20.00
	C06.24	Term. AIN Low Ref./Feedb. Value	-4999.000~4999.000	0.000

Item	Function Code	Fuction Description	Range&Function explanation	Default setting
Analog In / Out	C06.25	Term. AIN High Ref. /Feedb. Value	-4999.000~4999.000	50.000
	C06.26	Terminal AIN Filter Time Constant	0.01~10.00S	0.01
	C06.81	LCP potm. Low Ref. /Feedb. Value	-4999.000~4999.000	0.000
	C06.82	LCP potm. High Ref. /Feedb. Value	-4999.000~4999.000	50.000
	C06.90	Terminal AON Mode	*[0] 0-20 Ma [1] 4-20 mA [2] Digital Output	0
	C06.91	Terminal AON Analog Output	*[0] No operation [10] Output frequency [11] Reference [12] Feedback [13] Motor Current [16] Power [20] BusControl	10
	C06.92	Terminal AON Digital Output	See par. C05.40	0
	C06.93	Terminal AON Output Min Scale	0.00-200.00%	0.00%
C06.94	Terminal AON Output Max Scale	0.00-200.00%	100.00%	
Proess PI Contr-olers	C07.20	Process CL Feedback 1 Resource	*[0] NoFunction [1] Analog Input VIN [2] Analog Input AIN [8] PulseInput33 [11] LocalBusRef	0
	C07.30	Process PI Normal/ Inverse Ctrl	*[0] Normal [1] Inverse	0
	C07.31	Process PI Anti Windup	[0] Disable *[1] Enable	1
	C07.32	Process PI Start Speed	0.0~200.0	0.0
	C07.33	Process PI Proportional Gain	0.0~10.00	0.01
	C07.34	Process PI Integral Time	0.01~9999.00S	9999.00
	C07.38	Process PI Feed Forward Factor	0~400%	0%
	C07.39	On Reference Bandwidth	0-200%	5%

Item	Function Code	Fuction Description	Range&Function explanation	Default setting
Comm- unication	C08.01	Control Site	*[0] Digital and ControlWord [1] Digital only [2] ControlWord only	0
	C08.02	Control Word Source	[0] None *[1] FC RS485	1
	C08.03	Control Word Timeout Time	0.1~6500.0S	1.0S
	C08.04	Control Word Timeout Function	*[0] Off [1] Freeze Output [2] Stop [3] Jogging [4] Max. Speed [5] Stop and trip	0
	C08.06	Reset Control Word Timeout	*[0] No Function [1] Do reset	0
	C08.30	Protocol	*[0] FC [2] Modbus	0
	C08.31	Address	0~126	1
	C08.32	FC Port Baud Rate	[0] 2400 Baud [1] 4800 Baud *[2] 9600 Baud [3] 19200 Baud [4] 38400 Baud	2
	C08.33	FC Port Parity	*[0] Even Parity, 1 Stop Bit [1] Odd Parity, 1 Stop Bit [2] No Parity, 1 Stop Bit [3] No Parity, 2 Stop Bits	0
	C08.35	Minimum Response Delay	0.001~0.500S	0.010S
	C08.36	Max Response Delay	0.010~10.00S	5.000S

Item	Function Code	Fuction Description	Range&Function explanation	Default setting
Comm- unication	C08.50	Coasting Select	[0] DigitalInput [1] Bus [2] LogicAnd *[3] LogicOr	3
	C08.51	Quick Stop Select		3
	C08.52	DC Brake Select		3
	C08.53	Start Select		3
	C08.54	Reversing Select		3
	C08.55	Set-up Select		3
	C08.56	Preset Reference Select		3
	C08.94	Bus feedback 1	0x8000~0x7FFF	0
Special Function	C14.01	Switching Frequency	[0] 2 kHz *[1] 4 kHz [2] 8 kHz [4] 16 kHz	1
	C14.03	Overmodulation	[0] Off *[1] On	1
	C14.12	Function at mains imbalance	*[0] Trip [1] Warning [2] Disabled	0
	C14.20	Reset Mode	*[0] Manual reset [1] AutoReset 1 [2] AutoReset 2 [3] AutoReset 3 [4] AutoReset 4 [5] AutoReset 5 [6] AutoReset 6 [7] AutoReset 7 [8] AutoReset 8 [9] AutoReset 9 [10] AutoReset 10 [11] AutoReset 15 [12] AutoReset 20 [13] Infinite auto reset	0
	C14.21	Automatic Restart Time	0~600S	10S
	C14.22	Operation Mode	*[0] Normal Operation [2] Initialisation	0
	C14.26	Action At Inverter Fault	*[0] Trip [1] Warning	0
	C14.41	AEO Minimum Magnetisation	40~75%	66%

Item	Function Code	Fuction Description	Range&Function explanation	Default setting
Drive Information	C15.00	Operating Time	0 - 65535	0
	C15.01	Running Hours	0~2147483647	0
	C15.02	kWh Counter	0~65535	0
	C15.03	Power Ups	0~2147483647	0
	C15.04	Over Temps	0~65535	0
	C15.05	Over Volts	0~65535	0
	C15.06	Reset kWh Counter	*[0] Do not reset [1] Reset counter	0
	C15.07	Reset Running Hours Counter	*[0] Do not reset [1] Reset counter	0
	C15.30	Fault Log: Error Code	0~255	0
	C15.40	FC Type	View FC type	**
	C15.41	Power Section	View power section of frequency converter	**
	C15.42	Voltage	View voltage of frequency converter	**
	C15.43	Software Version	View power section of frequency converter	**
	C15.46	Frequency Converter Order. No	View ordering number for re-ordering	**
C15.48	LCP Id No	View LCP ID number	**	
C15.51	Frequency Converter Serial No	View frequency converter serial number	**	
Data Readouts	C16.00	Control Word	0~65535	0
	C16.01	Reference [Unit]	-4999.000~4999.000	0.000
	C16.02	Reference %	-200.0~200.0%	0.0
	C16.03	Status Word	0~65535	0
	C16.05	Main Actual Value [%]	-100.00~100.00%	0.00
	C16.09	Power [kW]	0.00~9999.00	0.00
	C16.10	Power [kW]	0~99KW	0KW
	C16.11	Power [hp]	0~99HP	0HP
	C16.12	Motor Voltage	0.0~999.9V	0.0
	C16.13	Frequency	0.0~400.0Hz	0.0Hz
	C16.14	Motor Current	0.00~1856.00A	0.00A

Item	Function Code	Fuction Description	Range&Function explanation	Default setting
Data Readouts	C16.15	Frequency [%]	-100.00~100.00%	0.00A
	C16.18	Motor Thermal	0~100%	0%
	C16.30	DC Link Voltage	0~10000V	0%
	C16.34	Heatsink Temp	0~255℃	0
	C16.35	Inverter Thermal	0~100%	0%
	C16.36	Inv. Nom. Current	0.01~10000.00A	0.00A
	C16.37	Inv. Max. Current	0.01~10000.00A	0.00A
	C16.50	External Reference	-200.0~200.0%	0.0%
	C16.51	Pulse Reference	-200.0~200.0%	0.0%
	C16.52	Feedback [Unit]	-4999.000~4999.000	0.000
	C16.60	Digital Input RUN,F/R,RST,EMS	0~1111	0
	C16.61	Digital Input JOG	0~1	0
	C16.62	Analog Input VIN (volt)	0.00~10.00V	0.00
	C16.63	Analog Input VIN (current)	0.00~20.00mA	0.00
	C16.64	Analog Input AIN	0.00~20.00mA	0.00
	C16.65	Analog Output AON [mA]	0.00~20.00mA	0.00
	C16.68	Pulse Input	20~5000Hz	20Hz
	C16.71	Relay Output [bin]	0~1	0
	C16.72	Counter A	-2147483648~2147483647	0
	C16.73	Counter B	-2147483648~2147483647	0
C16.86	FC Port REF 1	-200~200	0	
C16.90	Alarm Word	0~0xFFFFFFFF	0	
C16.92	Warning Word	0~0xFFFFFFFF	0	
C16.94	Ext. Status Word	0~0xFFFFFFFF	0	

VIII. Parameter Descriptions

1. Parameter group 0: Operation/Display

C00.04	Oper. State at Power-up (Hand)		Default setting	1
	Range	[0]	Resume	Frequency converter starts in same Hand or Off State as when powered off. Local reference is stored and used after power-up.
		[1]	Forced Stop, Ref=Old	Frequency converter powers up in Off State meaning that motor is stopped after power up. Local reference is stored and used after power-up.
		[2]	Forced Stop, Ref=0	Frequency converter powers up in Off State meaning that motor is stopped after power up. Local reference is set to 0. Thus motor will not start running before local reference has been increased.

- **Function:** This parameter controls whether or not the frequency converter should start running the motor when powering up after a power down in Hand mode.
- **ATTENTION!** If LCP with potmeter is mounted, reference is set according to actual potmeter value.

C00.1* Set-up Handling

User defined parameters and miscellaneous external inputs (eg. bus, LCP, analog/digital inputs, feedback, etc.) controls the functionality of the frequency converter. A complete set of all parameters controlling the frequency converter is called a set-up. The Micro Drive FC 51 contains 2 set-ups, Set-up1 and Set-up 2. Furthermore, a fixed set of Default setting settings can be copied into one or more set-ups.

Some of the advantages of having more than one set-up in the frequency converter are

- Run motor in one set-up (Active Set-up) while updating parameters in another set-up (Edit Set-up)

- Connect various motors (one at a time) to frequency converter. Motor data for various motors can be placed in different set-ups.
- Rapidly change settings of frequency converter and/or motor while motor is running (eg. ramp time or preset references) via bus or digital inputs.

The Active Set-up can be set as Multi Set-up where the active set-up is selected via input on a digital input terminal and/or via the bus control word.

ATTENTION! Default setting Set-up cannot be used as Active Set-up.

C00.3* Custom Readout

C00.31	Custom Readout Min Scale	Default setting	0.00
	Range	0.00-9999.00:	The value will be shown at 0Hz

- **Function:** Scale a readout parameter which can be read in par. C16.09

C00.32	Custom Readout Max Scale	Default setting	100
	Range	0.00-9999.00:	The value will be shown at the frequency programmed in par. C04.14.

- **Function:** Scale a readout parameter which can be read in par. C16.09

C00.4* LCP Keypad

The frequency converter can operate in the following three modes: Hand, Off and Auto.

Hand: The frequency converter is locally operated and does not allow any remote control. By activating Hand a start signal is given.

OFF: The frequency converter stops with a normal stop ramp. When Off is chosen the frequency converter can only be started by pressing either Hand or Auto on the LCP.

Auto: In Auto-mode the frequency converter can be remote controlled (bus/digital).

C00.40	[Hand on] Key on LCP		Default setting	1
	Range	[0]	Disabled	Hand-on key has no function.
		[1]	Enabled	Hand-on key is functional.

C00.41	[Off / Reset] Key on LCP		Default setting	1
	Range	[0]	Disable	Off/Reset Off/reset key has no function.
		[1]	Enable	Off/Reset Stop signal and reset of any faults.
		[2]	Enable Reset Only	Reset only. Stop (Off) function is disabled.

C00.42	[Auto on] Key on LCP		Default setting	1
	Range	[0]	Disabled	Auto-on key has no function.
		[1]	Enabled	Auto-on key is functional.

C00.60	Menu Locked		Default setting	0
	Range	[0]	Disable	allow for changing parameter values
		[1]	Enable	parameter can be read,but can't be edited

Parameter group 1: Load/Motor

C01.00	Configuration Mode		Default setting	0
	Range	[0]	Speed open loop	For normal speed control (References).
		[3]	Process Closed Loop	Enables process closed loop control. See par. group C07.3* or further information on PI-controller. When running in process closed loop, par. C04.10 Motor Speed Direction must be set to Clockwise [0]

- **Function:** Use this parameter for selecting the application control principle to be used when a Remote Reference is active.

C01.01	Motor Control Principle		Default setting	1
	Range	[0]	V/F	Is used for parallel connected motors and/or special motor applications.
		[1]	VVC+	Normal running mode, including slip- and load compensations.

- **Function:** The V/F settings are set in parameters C01.55 and C01.56.

C01.03	Torque Characteristics		Default setting	0
	Range	[0]	Constant Torque	Motor shaft output provides constant torque under variable speed control.
		[2]	Automatic Energy Optim.	This function automatically optimizes energy consumption in centrifugal pump and fan applications. See par. 14-41 AEO Minimum Magnetisation.

- **Function:** With more torque characteristics it is possible to run low energy consuming, as well as high torque applications.

C01.05	Local Mode Configuration		Default setting	2
	Range	[0]	Speed Open Loop	
		[2]	As configuration in par. C01.00	

- **Function:** This parameter is only relevant when parameter C01.00 Configuration Mode is set to Process Closed Loop [3]. The parameter is used for determining the reference or setpoint handling when changing from Auto Mode to Hand Mode on the LCP.
 - 0: In Hand Mode the drive always runs in Open Loop configuration regardless of setting in par. C01.00 Configuration Mode. Local potentiometer (if present) or Arrow up/down determines output frequency limited by Motor Speed High/Low Limit (parameters C04.14 and C04.12).
 - 2: If par. C01.00 Configuration Mode is set to Open Loop [1] function is as described above. If par. C01.00 is set to Process Closed Loop [3] changing from Auto mode to Hand mode results in a setpoint change via local potentiometer or Arrow up/down. The change is limited by Reference Max/Min (parameters C03.02 and C03.03)

0-2* Motor Data

- Function:** Enter the correct motor nameplate data (power, voltage, frequency, current and speed).
 Run AMT, see par. C01.29. Default setting settings for advanced motor data, par. C01.3*, are automatically calculated.
- ATTENTION!** Parameters in parameter group 1.2* cannot be adjusted while motor runs.

C01.20	Motor Power [kW] [HP]	Default setting	**
	Range	[0.09 kW/0.12 HP -11 kW/15 HP] Two sizes down, one size up from nominal VLT rating.	

- Function:** Enter motor power from nameplate data.

C01.22	Motor Voltage	Default setting	**
	Range	[50.0 - 999.0 V]	

- Function:** Enter motor voltage from nameplate data.

C01.23	Motor Frequency	Default setting	50
	Range	[20-400 Hz]	

- Function:** Enter motor frequency from nameplate data.
- ATTENTION!** Changing this parameter affects motor nominal speed set in par. C01.25.

C01.24	Motor Current	Default setting	**
	Range	[0.01 - 26.00 A]	

- Function:** Enter motor current from nameplate data.

C01.25	Motor Nominal Speed	Default setting	**
	Range	[100 - 9999 RPM]	

- Function:** Enter motor nominal speed from nameplate data.
- ATTENTION!** If Motor Frequency has been changed in par. C01.23, Nominal Motor Speed is affected.

C01.29	Automatic Motor Tuning (AMT)		Default setting	0
	Range	[0]	Off	AMT function is disabled.
		[2]	Enable AMT	AMT function starts running. This may take up to 10 min. depending on motor power rating.

- **Function:** Use AMT to optimize motor performance.
 - Stop VLT – make sure motor is at standstill
 - Choose [2] Enable AMT
 - Apply start signal
 - Via LCP: Press Hand On
 - Or in Remote On mode: Apply start signal on Terminal RUN
- **ATTENTION!** To gain optimum tuning of frequency converter, run AMT on a cold motor.

C01.3* Adv. Motor Data

Adjust advanced motor data using one of these methods:

1. Run AMT on cold motor. Frequency converter measures value from motor.
2. Enter X1 value manually. Obtain value from motor supplier.
3. Use X1 default setting. Frequency converter establishes setting based on motor nameplate data.

ATTENTION! This parameter cannot be changed while motor runs.

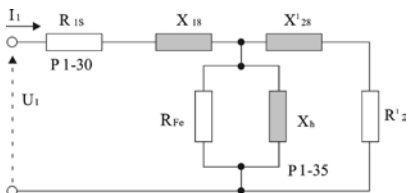

C01.30	Stator Resistance (R1s)		Default setting	**
	Range	Depending on motor data* [Ohm]		

- **Function:** Set stator resistance value.

C01.33	Stator Leakage Reactance (X1)	Default setting	**
	Range	Depending on motor data*[Ohm]	

- **Function:** Set stator leakage reactance of motor.

C01.35	Main Reactance (Xh)	Default setting	**
	Range	Depending on motor data*[Ohm]	

- **Function:** Set motor main reactance.

1-5* Load Independent Setting

This parameter group is for setting the load independent motor settings.

C01.50	Motor Magnetisation at 0 Speed	Default setting	100%
	Range	[0 - 300%]	Enter a percentage of rated magnetizing current. If setting is too low, motor shaft torque may be reduced.

- **Function:** This parameter enables different thermal load on motor when running at low speed.

C01.52	Min Speed Norm. Magnet. [Hz]	Default setting	0.0HZ
	Range	[0.0 - 10.0 Hz]	

- **Function:** Use this parameter along with par. C01.50, Motor Magnetizing at Zero Speed.
Set frequency required for normal magnetizing current. If frequency is set lower than motor slip frequency, par. C01.50, Motor Magnetizing at Zero Speed is inactive.

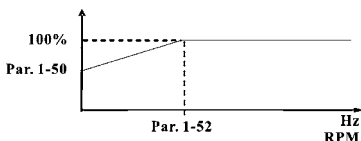

C01.55	V/F Characteristic - U	Default setting	0V
	Range	[0 - 999 V]	

- **Function:** This parameter is an array parameter [0-5] and is only functional when par. C01.01, Motor Control Principle is set to V/F [0]. Enter voltage at each frequency point to manually form a V/F characteristic matching motor. Frequency points are defined in par. C01.56, V/F characteristics - F.

C01.56	V/F Characteristic - F	Default setting	0HZ
	Range	[0 - 400 Hz]	

- Function:** This parameter is an array parameter [0-5] and is only functional when par. C01.01, Motor Control Principle is set to V/F [0]. Enter frequency points to manually form a V/F characteristic matching motor. Voltage at each point is defined in par. C01.55, V/F Characteristic - U.
 Make a V/F characteristic based on 6 definable voltages and frequencies, see below figure.
 Simplify V/F characteristics by merging 2 or more points (voltages and frequencies), respectively, are set equal.

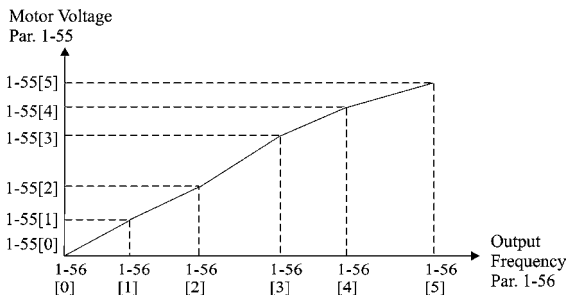

- ATTENTION!** For par. C01.56 the following applies $[0] \leq [1] \leq [2] \leq [3] \leq [4] \leq [5]$

C01.6* Load Dependent setting

Parameters for adjusting the load dependent motor settings.

C01.60	Low Speed Load Compensation	Default setting	100%
	Range	[0-199 %]	

- Function:** Use this parameter to gain optimum V/F characteristic when running at low speed.
 Enter percentage in relation to load when motor runs at low speed.
 Change-over point is automatically calculated based on motor size.

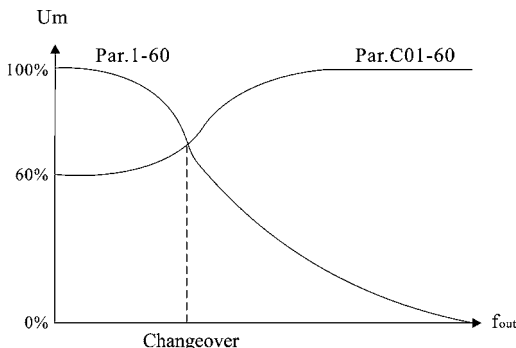

C01.61	High Speed Load Compensation	Default setting	100%
	Range	[0 - 199 %]	

- Function:** Use this parameter to obtain optimum load compensation when running at high speed.
 Enter percentage to compensate in relation to load when motor runs at high speed.
 Change-over point is automatically calculated based on motor size.

C01.62	Slip Compensation	Default setting	100%
	Range	[-400 - 399 %]	

- Function:** Compensation for load dependent motor slip. Slip compensation is calculated automatically based on rated motor speed, nM,N .
- ATTENTION!** This function is only active when par. C01.00, Configuration Mode, is set to Speed Open Loop [0], and when par. C01.01, Motor Control Principle, is set to VVC+ [1].

C01.63	Slip Compensation Time Constant	Default setting	0.10 s
	Range	[0.05 - 5.00 s]	

- Function:** 0.10 s [0.05 - 5.00 s] Enter slip compensation reaction speed. A high value results in slow reaction whereas a low value results in quick reaction.
 If low-frequency resonance problems arise, use longer time setting.

1-7* Start Adjustments

Considering the need for various start functions in different applications, it is possible to select a number of functions in this parameter group.

C01.71	Start Delay	Default setting	0.0S
	Range	[0.0 - 10.0 s]	

- Function:** The start delay defines the time to pass from a start command is given until the motor starts accelerating.
 Setting start delay to 0.0 sec. disables Start Function, [C01.72], when start command is given.
 Enter the time delay required before commencing acceleration. Par. C01.72 Start Function is active during Start delay time .

C01.72	Start Function	Default setting	2
	Range	[0]	DC Hold/Delay Time Motor is energized with DC holding current (par. C02.00) during start delay time.
		[1]	DC Brake/Delay Time Motor is energized with DC braking current (par. C02.01) during start delay time.
		[2]	Coast/Delay Time Inverter is coasted during start delay time (inverter off).

C01.73	Flying Start	Default setting	0
	Range	[0]	Disabled Flying start is not required.
		[1]	Enabled Frequency converter enabled to catch spinning motor.

- Function:** Use flying start to catch a spinning motor after eg. mains dropout.
- Warning:** This function is not suitable for hoisting applications.
- ATTENTION!** When flying start is enabled par. C01.71, Start Delay, and par. C01.72, Start Function, have no function.

C01.8* Stop Adjustments

To meet the need for various stop functions in different application these parameters offer some special stop features for the motor.

C01.80	Function at Stop		Default setting	0
	Range	[0]	Coast	The inverter is coasted.
		[1]	DC hold	The motor is energized with a DC current. See par. C02.00 DC Hold Current for more information.

- **Function:** The selected function at stop is active in following situations:
 - Stop command is given and output speed is ramped down to Min. Speed for Activating Functions at Stop.
 - Start command is removed (standby), and output speed is ramped down to Min. Speed for Activating Functions at Stop.
 - DC-brake command is given, and DC-brake time has passed
 - While running and calculated output speed is below Min. Speed for Activating Functions at Stop.

C01.82	Min Speed for Funct. at Stop [Hz]		Default setting	0.0HZ
	Range	[0.0 - 20.0 Hz]		

- **Function:** Set the speed at which to activate par. C01.80 Function at Stop.

C01.9* Motor Temperature

With an estimated motor temperature monitor the frequency converter is able to estimate motor temperature without having a thermistor mounted. It is thus possible to receive a warning or an alarm, if motor temperature exceeds upper operational limit.

C01.90	Motor Thermal Protection		Default setting	3
	Range	[0]	No Protection Disables temperature monitoring.	
		[1]	Thermistor Warning A thermistor connected to either digital or analog input gives a warning if upper limit of motor temperature range is exceeded, (see par. C01.93, Thermistor Resource).	
		[2]	Thermistor Trip A thermistor connected to either digital or analog input gives an alarm and makes the frequency converter trip if upper limit of motor temperature range is exceeded, (see par. C01.93, Thermistor Resource).	
		[3]	ETR Warning If calculated upper limit of motor temperature range is exceeded, a warning occurs.	
		[4]	ETR Trip If calculated upper limit of motor temperature range is exceeded, an alarm occurs and frequency converter trips.	

- **Function:** Using ETR (Electronic Terminal Relay) the motor temperature is calculated based on frequency, speed and time. Danfoss recommends using The ETR function, if a thermistor is not present.
- **ATTENTION!** ETR calculation is based on motor data from group C01.2*.

C01.93	Thermistor Resource		Default setting	0
	Range	[0]	None No thermistor is connected.	
		[1]	Analog Input VIN Connect thermistor to analog input Terminal VIN.	
		[6]	Digital Input JOG Connect thermistor to digital input Terminal JOG. While this input functions as thermistor input, it will not respond to the function chosen in par. C05.13, Digital Input JOG. The value of par. C05.13 remains however unchanged in parameter database while function is inactive.	

- **Function:** Select the thermistor input terminal.
- **ATTENTION!** Analog Input VIN cannot be selected for other purposes when selected as thermistor resource.

Input Digital/Analog Supply	Voltage Threshold Cut-out Values
Digital 10 V	<800 ohm - >2.9k ohm
Analog 10 V	<800 ohm - >2.9k ohm

Parameter group 2: Brakes

C02.0* DC-Brake

The purpose of DC-brake function is to brake a rotating motor by applying DC-current to the motor.

C02.00	DC Hold Current	Default setting	50%
	Range	[0 - 100%]	

- **Function:** This parameter either holds the motor (holding torque) or preheats the motor.
 - The parameter is active if DC Hold has been selected in either par. C01.72 Start Function or par. C01.80 Function at Stop.
 - Enter a value for holding current as a percentage of the rated motor current set in par. C01.24 Motor Current. 100% DC holding current corresponds to $I_{M,N}$.
- **ATTENTION!** Avoid 100% current too long as it may overheat the motor.

C02.01	DC Brake Current	Default setting	50%
	Range	[0 - 100%]	

- **Function:** Set DC-current needed to brake rotating motor.
Activate DC-brake in one of the four following ways:
 - DC-brake command, see par. C05.1* choice [5]
 - DC Cut-in function, see par. C02.04
 - DC-brake selected as start function, see par. C01.72
 - DC-brake in connection with Flying Start, par. C01.73.

C02.02	DC Braking Time	Default setting	10.0S
	Range	[0.0 - 60 s]	Set the time DC-braking current, set in par. C02.01, must be applied.

- **Function:**DC-braking time defines the period during which DC-brake current is applied to the motor.
- **ATTENTION!** If DC-brake is activated as start function, DC-brake time is defined by start delay time.

C02.04	DC Brake Cut In Speed	Default setting	0.0HZ
	Range	[0.0 - 400.0 Hz]	

- **Function:** Set DC-brake cut-in speed to activate DC braking current, set in par. C02.01, when ramping down.
When set to 0 the function is off.

C02.1* Brake Energy Function

Use the parameters in this group for selecting dynamic braking parameters.

C02.10	Brake Function	Default setting	0
	Range	[0]	Off No brake function.
		[1]	Resistor Brake Resistor brake is active.
		[2]	AC Brake AC brake is active.

- **Function:**
 - Resistor Brake:
The resistor brake limits voltage in the intermediate circuit when the motor acts as generator. Without brake resistor, the frequency converter eventually trips.
The resistor brake consumes surplus energy resulting from motor braking. A frequency converter with brake stops a motor faster than without a brake, which is used in many applications. Requires connection of external brake resistor. An alternative to the resistor brake is the AC brake.
 - AC Brake:
The AC brake consumes surplus energy by creating power loss in the motor.
It is important to keep in mind that an increase in power loss causes motor temperature to rise.
- **ATTENTION!** Resistor brake is only functional in frequency converters with integrated dynamic brake. An external resistor must be connected.

C02.11	Brake Resistor (ohm)	Default setting	*Ω
	Range	[5 - 5000 Ω]	

- **Function:** Set brake resistor value.

C02.16	AC Brake, Max current	Default setting	100%
	Range	[0 - 400 %]	

- **Function:** Enter max. permissible current for AC-braking to avoid overheating of motor.
100% equals motor current set in par. C01.24.

C02.17	Over-voltage Control		Default setting	0
	Range	[0]	Disabled	The OVC is not active/required.
		[1]	Enabled, not at stop	OVC is running unless a stop signal is active.
		[2]	Enabled	OVC is running, also when a stop signal is active.

- **Function:** Use Over-voltage Control (OVC) to reduce the risk of the frequency converter tripping due to an over voltage on the DC link caused by generative power from the load. An over-voltage occurs eg. if the ramp down time is set too short compared to the actual load inertia.
- **ATTENTION!** If Resistor Brake has been chosen in par. C02.10 Brake Function the OVC is not active even though enabled in this parameter.

2-2* Mechanical Brake

For hoisting applications an electro-magnetic brake is required. The brake is controlled by a relay, which releases the brake when activated. The brake activates if frequency converter trips or a coast command is given. Furthermore, it activates when motor speed is ramped down below the speed set in par. C02.22, Active Brake Speed.

C02.20	Release Brake Current		Default setting	0.00A
	Range	[0.00 - 100 A]		

- **Function:** Select motor current at which mechanical brake releases.
- **Warning:** If start delay time has passed, and motor current is below Release brake current, frequency converter trips.

C02.22	Activate Brake Speed [Hz]		Default setting	0
	Range	[0 - 400 Hz]	Select motor speed at which mechanical brake activates when ramping down.	

- **Function:** If the motor is stopped using ramp, the mechanical brake is activated when motor speed is less than Active Brake Speed. Motor is ramped down to stop in the following situations:
 - A start command is removed (stand by)
 - A stop command is activated
 - Quick-stop is activated (Q-stop ramp is used)
- Mechanical brake automatically activates if frequency converter trips or reports an alarm.

Parameter group 3: Reference/Ramps

Parameters for reference handling, definition of limitations, and configuration of the frequency converter's reaction to changes

3-0* Reference Limits

Parameters for setting the reference unit, limits and ranges.

C03.00	Reference Range			Default setting	0
	Range	[0]	Min - Max	Reference setpoint ranges can have positive values only. Select this if running in Process Closed Loop.	
		[1]	-Max-+Max	Ranges can have both positive and negative values.	

- Function:** Select the range of reference and feedback signals. Values can be both positive and negative, unless par. C01.00, Configuration Mode, is set to Process Closed Loop [3]. In that case only positive values are allowed.

C03.02	Minimum Reference		Default setting	0.000
	Range	[-4999.000 -4999.000]		

- Function:** Enter value for minimum reference. The sum of all internal and external referneces are clamped (limited) to the minimum reference value, par. C03.02.

C03.03	Maximum Reference		Default setting	50.000
	Range	[-4999.000 -4999.000]		

- Function:** Maximum Reference is adjustable in the range Minimum Reference- 4999.
Enter value for Maximum Reference.
The sum of all internal and external references are clamped (limited) to the maximum reference value, par. C03.03.

3-1* References

Parameters for setting up the reference sources. Select the preset references for the corresponding digital inputs in parameter group 5.1*, Digital Inputs.

18 Bit2	17 Bit1	16 Bit0	Preset reference no.
0	0	0	0
0	0	1	1
0	1	0	2
0	1	1	3
1	0	0	4
1	0	1	5
1	1	0	6
1	1	1	7

Table 4.1: Par. C05.1* selection [16], [17] and [18]

C03.10	Preset Reference	Default setting	0.00%
	Range	[-100.00 - 100.00%]	

- **Function:** Each parameter set-up contains 8 preset references which are selectable via 3 digital inputs or bus.

Enter the different preset references using array programming. Normally, 100% = value set in par. C03.03,

Maximum Reference. However, there are exceptions if par. C03.00 is set to Min - Max, [0].

Example 1: Par. C03.02 is set to 20 and par. C03.03 is set to 50. In this case 0% = 0 and 100% = 50.

Example 2: Par. C03.02 is set to -70 and par. C03.03 is set to 50. In this case 0% = 0 and 100% = 70.

C03.11	Jog Speed [Hz]	Default setting	5.0HZ
	Range	[0.0 - 400.0 Hz] Select speed to function as jog speed.	

- **Function:** Jog speed is a fixed output speed and overrules the selected reference speed, see par. C05.1* selection [14].

If the motor is stopped while in jog mode, the jog signal acts as a start signal. Removing the jog signal makes the motor run according to the selected configuration.

C03.12	Catch up/slow Down Value	Default setting	0.00%
	Range	[0.00 - 100.00%]	

- **Function:** The Catch-up/Slowdown function is activated by an input command (see par. C05.1*, choice [28]/[29]). If the command is active,

the Catch-up/Slowdown value (in %) is added to the reference function as follows:

$$\text{Reference} = \text{Reference} + \text{reference} \times \text{Catchup Slowdown} / 100$$

$$\text{Reference} = \text{Reference} - \text{reference} \times \text{Catchup Slowdown} / 100$$

When the input command is inactivated, the reference returns to its original value ie. $\text{Reference} = \text{Reference} + 0$.

C03.14	Preset Relative Reference	Default setting	0.00%
	Range	[-100.00 - 100.00%]	

- Function:** Define fixed value in % to be added to variable value defined in par. C03.18, Relative Scaling Reference Source. The sum of fixed and variable values (labelled Y in illustration below) is multiplied with actual reference (labelled X in illustration). This product is added to actual reference $X + X * Y / 100$

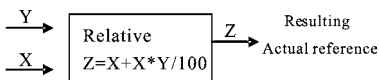

C03.15	Reference Resource 1	Default setting	1
	Range	[0]	No Function No reference signal is defined.
		[1]	Analog Input VIN Use signals from analog Input VIN as reference, see par. C06.1*.
		[2]	Analog Input AIN Use signals from analog Input AIN as reference, see par. C06.2*.
		[8]	Pulse input Use signals from pulse input as reference, see par. C05.5*.
		[11]	Local Bus Ref. Use signals from local bus as reference, see par. C08.9*.
		[21]	LCP Potentiometer Use signals from LCP potentiometer as reference, see par. C06.8*.

- Function:** Par. C03.15, C03.16 and C03.17 define up to three different reference signals. The sum of these reference signals defines the actual reference.

C03.16	Reference Resource 2	Default setting	2
	Range	[0]	No Function No reference signal is defined.
		[1]	Analog Input VIN Use signals from analog Input VIN as reference.
		[2]	Analog Input AIN Use signals from analog Input AIN as reference.
		[11]	Local Bus Ref. Use signals from local bus as reference.
		[21]	LCP Potentiometer Use signals from LCP potentiometer as reference.

- **Function:** See Par. C03.15 for description.

C03.17	Reference Resource 3	Default setting	11
	Range	[0]	No Function No reference signal is defined.
		[1]	Analog Input VIN Use signals from analog Input VIN as reference.
		[2]	Analog Input AIN Use signals from analog Input AIN as reference.
		[11]	Local Bus Ref. Use signals from local bus as reference.
		[21]	LCP Potentiometer Use signals from LCP potentiometer as reference.

- **Function:** See Par. C03.15 for description.

C03.18	Relative Scaling Ref. Resource	Default setting	0
Range	[0]	No Function The function is disabled	
	[1]	Analog Input VIN Select analog Input VIN as relative scaling reference source.	
	[2]	Analog Input 54 Select analog input 54 as relative scaling reference source.	
	[8]	Pulse Input 33 Select pulse input 33 as relative scaling reference source.	
	[11]	Local Bus Ref. Select local bus ref. as relative scaling reference source.	
	[21]	LCP Potentiometer Select LCP potentiometer as relative scaling reference source.	

- **Function:** Select the source for a variable value to be added to the fixed value defined in par. C03.14, Preset Relative Reference.

3 – 4* Ramp 1

A linear ramp is characterized by ramping up at a constant speed until the desired motor speed has been reached. Some overshoot may be experienced when reaching speed, which may cause speed jerks for a short while before stabilizing.

An S-ramp accelerates more smoothly thus compensating for jerks when the speed is reached.

See the below figure for a comparison of the two ramp types.

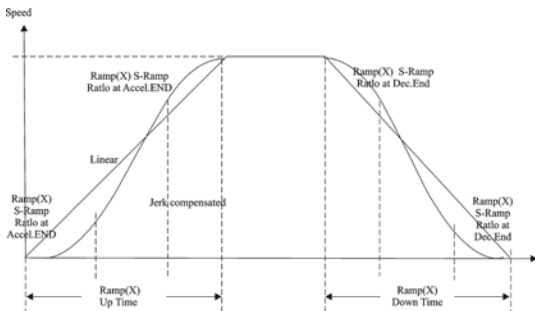

Ramp Times:

Ramp up: Acceleration time. From 0 to nominal motor frequency (par. C01.23).

Ramp down: Deceleration time. From nominal motor frequency (par. C01.23) to 0.

Limitation:

Too short ramp up time can result in Torque limit warning (W12) and/or DC over voltage warning (W7). Ramping is stopped when the frequency converter has reached Torque limit motor mode (par. C04.16).

Too short ramp down time can result in Torque limit warning (W12) and/or DC over voltage warning (W7). Ramping is stopped when the frequency converter reaches the Torque limit generator mode (par. C04.17) and/or the internal DC over voltage limit.

C03.40	Ramp 1 Type			Default setting	0
	Range	0	Linear	Constant acceleration/deceleration.	
		2	S-ramp	Smooth jerk compensated acceleration/deceleration.	

C03.41	Ramp 1 Ramp up Time			Default setting	3.00/ 15.00S*
	Range	[0.05 - 3600 s]			

- **Function:** Enter ramp-up time from 0 Hz to rated motor speed (nM,N) set in par. C01.25.

Choose a ramp-up time ensuring that output current does not exceed current limit set in par. C04.18 during ramping.

* only for NV4,NV5

C03.42	Ramp 1 Ramp Down Time			Default setting	3.00 /30.00S*
	Range	[0.05 - 3600 s]			

- **Function:** Enter ramp down time from rated motor speed nM,N in par. C01.25 to 0 Hz.

Choose a ramp down time that does not cause over-voltage in inverter due to regenerative operation of motor. Furthermore, generated current must not exceed current limit set in par. C04.18.

* only for NV4,NV5

C03.5* Ramp2

See par. C03.4* for a description of ramp types.

ATTENTION! Ramp2 - alternative ramp times: Changing from Ramp1 to Ramp2 is done via the digital input. See par. C05.1*, selection[34].

C03.50	Ramp 2 Type		Default setting	0
	Range	[0]	Linear	Constant acceleration/deceleration.
		[2]	S-ramp	Smooth jerk compensated acceleration/deceleration.

C03.51	Ramp 2 Ramp up Time		Default setting	3.00/ 15.00S*
	Range	[0.05 - 3600 s]		

- **Function:** Enter ramp-up time from 0 Hz to rated motor speed (nM,N) set in par. C01.25.

Choose a ramp-up time ensuring that output current does not exceed current limit set in par. C04.18 during ramping.

* only for NV4,NV5

C03.52	Ramp 2 Ramp down Time		Default setting	3.00/ 30.00S*
	Range	[0.05 - 3600 s]		

- **Function:** Enter ramp down time from rated motor speed nM,N in par. C01.25 to 0 Hz.

Choose a ramp down time that does not cause over-voltage in inverter due to regenerative operation of motor. Furthermore, generated current must not exceed current limit set in par. C04.18.

* only for NV4,NV5

C03.8* Other Ramps

This section contains parameters for Jog and Quick Stop Ramp

With a Jog Ramp you can both ramp up and down whereas you can only ramp down with the Quick Stop Ramp.

C03.80	Jog Ramp Time		Default setting	3.00/ 15.00S*
	Range	[0.05 - 3600 s]		

- **Function:** A linear ramp applicable when Jog is activated. See par. C05.1*, selection [14].

Ramp up time = Ramp down time.

Jog Ramp time starts upon activation of a jog signal via a selected digital input or serial communication port.

* only for NV4,NV5

C03.81	Quick Stop Ramp Time	Default setting	3.00/ 30.00S*
	Range	[0.05 - 3600 s]	

- **Function:** A linear ramp applicable when Q-stop is activated. See par. C05.1*, selection [4].

* only for NV4,NV5

Parameter group 4: Motor Limits

Parameter group for configuring limits and warning.

C04.1* Motor Limits

Use these parameters for defining the speed, torque and current working range for the motor.

C04.10	Motor Speed Direction	Default setting	2
	Range	[0] Clockwise	The motor shaft rotates in clockwise direction. This setting prevents the motor from running in counterclockwise direction. If par. C01.00 Configuration mode has been set to Process Closed Loop [3] this parameter must always be set to Clockwise
		[1] Counterclockwise	The motor shaft rotates in counterclockwise direction. This setting prevents the motor from running in clockwise direction.
		[2] Both	With this setting the motor can run in both directions. However, the output frequency is limited to the range: Motor Speed Low Limit (par. C04.12) to Motor Speed High Limit (par. C04.14).

- **Function:** If terminals 96, 97 and 98 are connected to U, V and W respectively, the motor runs clockwise when seen from the front.
- **ATTENTION!** This parameter cannot be adjusted while the motor is running

C04.12	Motor Speed Low Limit [Hz]	Default setting	0.0HZ
	Range	[0.0 - 400.0 Hz]	

- **Function:** Set the Minimum Motor Speed Limit corresponding to the minimum output frequency of the motor shaft.
- **ATTENTION!** As the minimum output frequency is an absolute value, it cannot be deviated from.

C04.14	Motor Speed High Limit [Hz]	Default setting	65.0HZ
	Range	[0.0 - 400.0 Hz]	

- **Function:** Set the Maximum Motor Speed corresponding to the maximum output frequency of the motor shaft.
- **ATTENTION!** As the maximum output frequency is an absolute value, it cannot be deviated from.

C04.16	Torque Limit Motor Mode	Default setting	150%
	Range	[0 - 400%]	

- **Function:** Set the torque limit for motor operation.
The setting is not automatically reset to default when changing settings in par. C01.00 to C01.25 Load & Motor .

C04.17	Torque Limit Generator Mode	Default setting	100%
	Range	[0 - 400 %]	

- **Function:** Set the torque limit for generator mode operation.
The setting is not automatically reset to default when changing settings in par. C01.00 to C01.25 Load & Motor.

C04.5* Adjustable Warnings

Parameter group containing adjustable warning limits for current, speed, reference and feedback.

Warnings are shown in display, programmed output or serial bus.

C04.50	Warning Current Low	Default setting	0.00A
	Range	[0.00 - 26.00 A]	

- **Function:** Use this parameter to set a lower limit for the current range. If current drops below the set limit, a warning occurs.

C04.51	Warning Current High	Default setting	26.00A
	Range	[0.00 - 100.00 A]	

- **Function:** Use this parameter to set an upper limit for the current range. If current exceeds the set limit, a warning occurs.

C04.58	Missing Motor Phase Function	Default setting	1
	Range	[0]	Off Function is disabled.
		[1]	On Function is enabled.

- Function:** A missing motor phase causes the motor torque to drop. This monitor may be disabled for special purposes (eg. small motors running pure V/F mode), but as there is a risk of overheating the motor, Danfoss strongly recommends that the function is On.
 A missing motor phases causes the frequency converter to trip and report an alarm.
- ATTENTION!** This parameter cannot be changed while motor runs.

C04.6* Speed Bypass

In some applications mechanical resonance may occur. Avoid resonance points by creating a bypass. The frequency converter ramps through the bypass area thereby passing mechanical resonance points quickly.

C04.61	Bypass Speed From [Hz]	Default setting	0.0Hz
	Range	[0.0 - 400.0 Hz]	

- Function:** Array [2]
 Enter either the lower or upper limit of the speeds to be avoided. It does not matter whether Bypass From or Bypass Too is the upper or lower limit, however the Speed Bypass function is disabled if the two parameters are set to the same value.

C04.63	Bypass Speed To [Hz]	Default setting	0.0Hz
	Range	[0.0 - 400.0 Hz]	

- Function:** Array [2]
 Enter either the upper or lower limit of the speed area to be avoided. Make sure to enter the opposite limit of that in par. C04.61 Speed Bypass From [Hz].

Parameter group 5: Digital In/Out

The following describes all digital input command functions and signals.

C05.1* Digital Inputs

Parameters for configuring the functions for the input terminals. The digital inputs are used for selecting various functions in the frequency converter. All digital inputs can be set to the following:

C05.10	Terminal RUN Digital Input	Default setting	8
C05.11	Terminal F/R Digital Input	Default setting	10
C05.12	Terminal RST Digital Input	Default setting	1
C05.13	Terminal JOG Digital Input	Default setting	14
C05.15	Terminal EMS Digital Input	Default setting	16
	Range	See the following table	

[0] No Operation	The frequency converter will not react to signals transmitted to the terminal.
[1] Reset	Reset the frequency converter after a Trip/Alarm. Not all alarms can be reset.
[2] Coast Inverse	Coasting stop, inverted input (NC). The frequency converter leaves the motor in free mode.
[3] Coast and reset inv.	Reset and coasting stop inverted input (NC). The frequency converter resets and leaves the motor in free mode.
[4] Quick stop inverse	Inverted input (NC). Generates a stop in accordance with the quick-stop ramp time set in par. C03.81. When motor stops, shaft is in free mode.
[5] DC-brake inv.	Inverted input for DC braking (NC). Stops motor by energizing it with DC current for a certain time period, see par. C02.01. Function is only active when value in par. C02.02 is different from 0.
[6] Stop inv.	Stop inverted function. Generates stop function when selected terminal goes from logical level "1" to "0". Stop is performed according to selected ramp time.
[8] Start	Select start for a start/stop command. 1 = Start, 0 = stop.
[9] Latched start	Motor starts if a pulse is applied for min. 2 ms. Motor stops when Stop inverse is activated.
[10] Reversing	Change direction of motor shaft rotation. Reversing signal only

	changes direction of rotation; it does not activate start function. Select Both directions [2] in par. 4.10.
0 = normal, 1 = reversing.	
[11] Start reversing	Use for start/stop and for reversing at the same time. Signals on start [8] are not allowed at the same time. 0 = stop, 1 = start reversing.
[12] Enable start forward	Use if motor shaft must rotate clockwise at start.
[13] Enable start reverse	Use if motor shaft must rotate counterclockwise at start.
[14] Jog Use for activating jog speed.	See par. C03.11.
[16] Preset ref bit 0	Preset ref bit 0, 1 and 2 enables a choice between one of the eight preset references according to the table below.
[17] Preset ref bit 1	Same as preset ref bit 0 [16], see par. C03.10.
[18] Preset ref bit 2	Same as preset ref bit 0 [16].
[19] Freeze reference	Freeze actual reference. The frozen reference is now the point of enable/condition for Speed up and Speed down to be used. If Speed up/down is used, speed change always follows ramp 2 (par. C03.51 and C03.52) in the range par. C03.02 Minimum Reference - par. C03.03 Maximum Reference.
[20] Freeze output	Freeze the actual motor frequency (Hz). The frozen motor frequency is now the point of enable/condition for Speed up and Speed down to be used. If Speed up/down is used, the speed change always follows ramp 2 in the range par. C04.12, Motor Speed Low Limit - par. C04.14, Motor Speed High Limit
ATTENTION! When freeze output is active, the frequency converter cannot be stopped via a low Start [8] signal.	
Stop the frequency converter via a terminal programmed for Coasting Inverse [2] or Coast and reset, inverse [3].	

[21] Speed up	Select Speed up and Speed down if digital control of the up/down speed is desired (motor potentiometer). Activate this function by selecting either Freeze reference or Freeze output.
When Speed up is activated	for less than 400 ms. the resulting reference will be increased by 0.1%. If Speed up is activated for more than 400 ms. the resulting reference will ramp according to ramp 2 in par. C03.51.
[22] Speed down	Same as Speed up [21].
[23] Setup select bit 0	Set par. C00.10 Active set-up to Multi set-up. Logic 0 = set-up 1, Logic 1 = Set-up 2.
[26] Precise stop inverse	Prolong the stop signal to give a precise stop independent of scan time. The function is available for Terminal EMS only.
[27] Start, precise stop	As [26], but including Start.
[28] Catch up	Select Catch up/Slow down to increase or reduce the resulting reference value by the percentage set in par. C03.12.
[29] Slow down	Same as Catch up [28]
[32] Pulse input (only Terminal EMS)	Select Pulse input when using a pulse sequence as either reference or feedback. Scaling is done in par. group C05.5*.
[34] Ramp bit 0	Logic 0 = Ramp1, see par. C03.4*. Logic 1 = Ramp2, see par. C03.5*.
[60] Counter A(up)	Input for counter A.
[61] Counter A(down)	Input for counter A.
[62] Reset counter A	Input for reset of counter A.
[63] Counter B(up)	Input for counter B.
[64] Counter B(down)	Input for counter B.
[65] Reset counter B	Input for reset of counter B.

C05.4* Relays

Parameter group for configuring timing and output functions for relays.

C05.40	Function Relay	Default setting	9
	Range	See the following table	

[0] No Operation	Default for all digital and relay outputs.
[1] Control Ready	Control board receives supply voltage.
[2] Drive Ready	Frequency converter is ready for operation and applies supply signal on control board.
[3] Drive Ready, Remote	Frequency converter is ready for operation in Auto On-mode.
[4] Enable/No Warning	Frequency converter is ready for operation. No start or stop command is given. No warnings are present.
[5] Drive Running	Motor is running.
[6] Running/No Warning	Motor runs, and no warning are present.
[7] Run in Range/No Warning	Motor runs within programmed current ranges, see parameters C04.50 and C04.51. No warnings are present.
[8] Run on ref/No Warning	Motor runs at reference speed.
[9] Alarm	An alarm activates output.
[10] Alarm on Warning	An alarm or warning activates output.
[12] Out of Current	Range Motor current is outside range set in parameters C04.50 and C04.51.
[13] Below Current, low	Motor current is lower than set in par. C04.50.
[14] Above Current, high	Motor current is higher than set in par. C04.51.
[21] Thermal Warning	Thermal warning is present when temperature exceeds limit in motor, frequency converter, brake resistor or thermistor.
[22] Ready, No Thermal Warning	Frequency converter is ready for operation and no over-temperature warning is present.
[23] Remote Ready, No Thermal Warning	Frequency converter is ready for operation in Auto mode, and no over-temperature warning is present.
[24] Ready, Voltage OK	Frequency converter is ready for operation and mains voltage is within

[25] Reverse	specified voltage range. Motor runs/is ready to run clockwise when logic = 0 and counter clockwise when logic = 1. Output changes as soon as reversing signal is applied.
[26] Bus OK	Active communication (no time-out) via serial communication port.
[28] Brake, No Warn	Brake is active, and no warnings are present.
[29] Brake Ready/No Fault	Brake is ready for operation, and no faults are present.
[30] Brake Fault (IGBT)	Protects frequency converter if fault on brake modules is present. Use relay to cut out main voltage from frequency converter.
[32] Mech. Brake Control	Enables control of external mechanical brake, see parameter group C02.2*.
[36] Control Word Bit 11	Bit 11 in control word controls relay.
[51] Local Ref Active	
[52] Remote Ref Active	
[53] No Alarm	
[54] Start Cmd Active	
[55] Running Reverse	

5-5* Pulse Input

Set par. C05.15 to choice [32] pulse input. Now Terminal EMS handles a pulse input in the range from Low frequency, par. C05.55, to High frequency, par. C05.56. Scale frequency input via par. C05.57 and par. C05.58.

C05.55	Terminal EMS Low Frequency	Default setting	20
	Range	[20 - 4999 Hz]	

- **Function:** Enter low frequency corresponding to low motor shaft speed (i.e. low reference value) in par. C05.57.

C05.56	Terminal EMS High Frequency	Default setting	5000
	Range	[21 - 5000 Hz]	

- **Function:** Enter high frequency corresponding to high motor shaft speed (i.e. high reference value) in par. C05.58.

C05.57	Term. EMS Low Ref./Feedb. Value	Default setting	0.000
	Range	[-4999.000 -4999.000]	

- **Function:** Set reference/feedback value corresponding to low pulse frequency value set in par. C05.55.

C05.58	Term. EMS High Ref./Feedb. Value	Default setting	50.000
	Range	[-4999.000 -4999.000]	

- **Function:** Set reference/feedback value corresponding to high pulse frequency value set in par. C05.56.

Parameter group 6: Analog In/Out

Parameter group for configuring analog inputs and outputs.

C06.0* Analog I/O Mode

Parameter group for setting up the analog I/O configuration.

C06.00	Live Zero Timeout Time	Default setting	10s
	Range	[1 - 99 s]	

- **Function:** The Live Zero function is used for monitoring the signal on an analog input. If the signal disappears, a Live Zero warning is reported.

Set delay time before Live Zero Timeout Function is applied (par. C06.01).

If the signal reappears during the set delay, timer will be reset. When live zero is detected, the frequency converter freezes output frequency and starts Live Zero Timeout timer.

C06.01	Live Zero Timeout Function	Default setting	0
	Range	[0]	Off Function is disabled.
		[1]	Freeze output Output frequency remains at value it had when live zero was detected.
		[2]	Stop Frequency converter ramps down to 0 Hz. Remove live zero error condition before restarting frequency converter.
		[3]	Jogging Frequency converter ramps to jog speed, see par. C03.41.
		[4]	Max Speed Frequency converter ramps to Motor Speed High Limit, see par. C04.14.
		[5]	Stop and Trip Frequency converter ramps down to 0 Hz and then trips. Remove live zero condition and activate reset before restarting the frequency converter.

- **Function:** Function is activated if input signal is below 50% of value set in parameters C06.10, C06.12 or C06.22.

C06.1* Analog Input 1

Parameters for configuring scaling and limits for analog input 1 (Terminal VIN).

ATTENTION!

Micro switch XXX in position U: Parameters C06.10 and C06.11 are active.

Micro switch in position I: Parameters C06.12 and C06.13 are active.

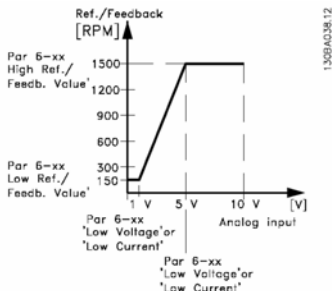

C06.10	Terminal VIN Low Voltage	Default setting	0.07V
	Range	[0.00 - 9.99V]	Enter low voltage value.

- **Function:** This scaling value should correspond to minimum reference value set in par. C06.14. See also section Reference Handling.

C06.11	Terminal VIN High Voltage	Default setting	10.00V
	Range	[0.10 - 10.00 V]	Enter high voltage value.

- **Function:** This scaling value should correspond to maximum reference value set in par. C06.15.

C06.12	Terminal VIN Low Current	Default setting	0.14
	Range	[0.00 - 19.99 mA]	Enter low current value.

- **Function:** This reference signal should correspond to minimum reference value set in par. C03.02.
- **Warning:** The value must be set to min. 2 mA in order to activate the Live Zero Timeout function in par. C06.01.

C06.13	Terminal VIN High Current	Default setting	20.00
	Range	[0.10 - 20.00 mA]	Enter high current value.

- **Function:** This reference signal should correspond to the maximum reference value set in par. C06.15.

C06.14	Term. VIN Low Ref./Feedb. Value	Default setting	0.000
	Range	[-4999.000 -4999.000]	Enter analog input scaling value.

- **Function:** The scaling value corresponding to the low voltage/low current set in parameters C06.10 and C06.12.

C06.15	Term. VIN High Ref./Feedb. Value	Default setting	50.000
	Range	[-4999.000 -4999.000]	Enter analog input scaling value.

- **Function:** The scaling value corresponding to the maximum reference feedback value set in parameters C06.11 and C06.13.

C06.16	Terminal VIN Filter Time Constant	Default setting	0.01s
	Range	[0.01 - 10.00 s]	Enter time constant.

- **Function:** A first-order digital low pass filter time constant for suppressing electrical noise in Terminal VIN. A high time constant value improves dampening but also increases time delay through the filter.
- **ATTENTION!** This parameter cannot be adjust while motor is running.

C06.19	Terminal VIN mode	Default setting	0
	Range	[0]	[0] * Voltage Mode
		[1]	[1] Current Mode

- **Function:** Select the input to be present on Terminal VIN.
- **Warning:** Par. C06.19 MUST be set according to Micro switch XXX setting.

C06.2* Analog Input 2

Parameters for configuring scaling and limits for analog input 2, Terminal AIN.

C06.22	Terminal AIN Low Current	Default setting	0.14
	Range	[0.00 - 19.99 mA]	Enter low current value.

- **Function:** This reference signal should correspond to minimum reference value set in par. C03.02.
- **Warning:** The value must be set to min. 2 mA in order to activate the Live Zero Timeout function in par. C06.01.

C06.23	Terminal AIN High Current	Default setting	20.00
	Range	[0.10 - 20.00 mA]	Enter high current value.

- **Function:** This reference signal should correspond to the high current value set in par. C06.25.

C06.24	Term. AIN Low Ref./Feedb. Value	Default setting	0.000
	Range	[-4999.000 -4999.000]	Enter analog input scaling value.

- **Function:** The scaling value should correspond to the minimum reference feedback value set in par. C03.02.

C06.25	Term. AIN High Ref./Feedb. Value	Default setting	50.000
	Range	[-4999.000 -4999.000]	Enter analog input scaling value.

- **Function:** The scaling value should correspond to the maximum reference feedback value set in par. C03.03.

C06.26	Terminal AIN Filter Time Constant	Default setting	0.01s
	Range	[0.01 - 10.00 s] Enter time constant.	

- **Function:** A first-order digital low pass filter time constant for suppressing electrical noise in terminal 54. A high time constant value improves dampening, but also increases time delay through the filter.
- **ATTENTION!** This parameter cannot be changed while motor runs.

C06.8* LCP Potmeter

The LCP potmeter can be selected either as Reference Resource or Relative Reference Resource.

ATTENTION! In Hand mode the LCP potmeter functions as local reference.

C06.81	LCP potm. Low Ref./Feedb. Value	Default setting	0.000
	Range	[-4999.000 -4999.000]	

- **Function:** The scaling value corresponding to 0.
Enter low reference value. The reference value corresponding to potentiometer turned fully counterclockwise (0 degrees).

C06.82	LCP potm. High Ref./Feedb. Value	Default setting	50.000
	Range	[-4999.000 -4999.000]	

- **Function:** The scaling value corresponding to the maximum reference feedback value set in par. C03.03.
Enter high reference value. The reference value corresponding to potentiometer turned fully clockwise (200 degrees).

C06.9* Analog Output

These parameters are for configuring the analog outputs of the frequency converter.

C06.90	Terminal AON Mode	Default setting	0
	Range	[0]	0 - 20 mA Range for analog outputs is 0-20 mA
		[1]	4-20 mA Range for analog outputs is 4 - 20 mA
		[2]	Digital Functions as slow reacting digital output. Set value to either 0 mA (off) or 20 mA (on), see par. C06.92.

C06.91	Terminal AON Analog Output		Default setting	10
	Range	[0]	No Operation	
		[10]	Output Frequency	
		[11]	Reference	
		[12]	Feedback	
		[13]	Motor Current	
		[16]	Power	
		[20]	Speed	

- **Function:** Select the function for Terminal AON as an analog output.

C06.92	Terminal AON Digital Output		Default setting	0
	Range	See par. C05.4*,		

- **Function:** See par. C05.4*,Relays, for choices and descriptions.

C06.93	Terminal AON Output Min Scale		Default setting	0.00%
	Range	[0.00 - 200.00%]		

- **Function:** Scale minimum output of selected analog signal at Terminal AON as percentage of maximum signal value. E.g. if 0 mA (or 0 Hz) is desired at 25% of maximum output value, programme 25%. Scaling values up to 100% can never be higher than corresponding setting in par. C06.52.

C06.94	Terminal AON Output Max Scale		Default setting	100.00%
	Range	[0.00 – 200.00%]		

- **Function:** Scale maximum output of selected analog signal at Terminal AON. Set value to maximum value of current signal output. Scale output to give a current lower than 20 mA at full scale; or 20 mA at an output below 100% of maximum signal value. If 20 mA is the desired output current at a value between 0 -100% of the full-scale output, programme percentage value in the parameter, i.e. 50% = 20 mA. If a current between 4 and 20 mA is desired at maximum output (100%), calculate percentage value as follows: 20 mA/desired maximum current × 100 %
i.e. 10 mA = 20/10 × 100 = 200%

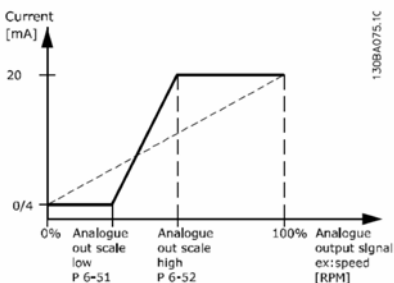

Parameter group 7: Controllers

Parameters group for configuring application controls.

C07.2* Process Ctrl. Feedb

Select feedback sources and handling for Process PI Control.

C07.20	Process CL Feedback 1 Resource		Default setting	0
	Range	[0]	No Function	
		[1]	Analog Input VIN	
		[2]	Analog Input AIN	
		[8]	Pulse Input 33	
		[11]	Local Bus Ref.	

- **Function:** Select input to function as feedback signal.

C07.3* Process PI Control

C07.30	Process PI Normal/ Inverse Ctrl		Default setting	0
	Range	[0]	Normal	Feedback larger than setpoint result in a speed reduction. Feedback less than setpoint result in a speed increase.
		[1]	Inverse	Feedback larger than setpoint result in a speed increase. Feedback less than setpoint result in a speed reduction.

C07.31	Process PI Anti Windup			Default setting	1
	Range	[0]	Disable	Regulation of a given error will continue even when the output frequency cannot be increased/decreased.	
		[1]	Enable	PI-controller ceases from regulating a given error when the output frequency cannot be increased/decreased.	

C07.32	Process PI Start Speed		Default setting	0.0
	Range	[0.0 - 200.0 Hz]		

- **Function:** Until the set motor speed has been reached the frequency converter operates in Open Loop mode.

C07.33	Process PI Proportional Gain		Default setting	0.01
	Range	[0.00 - 10.00]		

- **Function:** Enter the value for the P proportional gain, i.e. the multiplication factor of the error between the set point and the feedback signal.
- **NOTE:** 0.00 = Off.

C07.34	Process PI Integral Time		Default setting	9999.00s
	Range	[0.01 - 9999.00 s]		

- **Function:** The integrator provides an increasing gain at a constant error between the set point and the feedback signal. The integral time is the time needed by the integrator to reach the same gain as the proportional gain.

C07.38	Process PI Feed Forward Factor		Default setting	0%
	Range	[0 - 400%]		

- **Function:** The FF factor sends a part of the reference signal around the PI controller which then only affects part of the control signal. By activating the FF factor less overshoot and high dynamics are gained when changing the setpoint. This parameter is always active when par. C01.00 Configuration Mode is set to Process [3].

C07.39	On Reference Bandwidth		Default setting	5%
	Range	[0 - 200%]		

- **Function:** Enter the value for the On Reference Bandwidth.
The PI control error is the difference between setpoint and feedback and when this is less than the value set in this parameter the On Reference is active.

Parameter group 8: Communication

Parameter group for configuring communication.

8-0* General Settings

Use this parameter group for configuring the general settings for communication.

C08.01	Control Site		Default setting	0
	Range	[0]	Digital and Control Word Use both digital input and control word as control.	
		[1]	Digital Only Use digital input as control.	
		[2]	Control Word Only Use control word only as control.	

- **Function:** The setting in this parameter overrules settings in par. C08.50 to C08.56.

C08.02	Control Word Source		Default setting	1
	Range	[0]	None	Function is inactive
		[1]	FC RS485	Monitoring control word source is done via serial communication port RS485.

C08.03	Control Word Timeout Time		Default setting	1.0S
	Range	[0.1 - 6500.0 s]		

- **Function:** Enter time to pass before control word timeout function (par. C08.04) must be carried out.

C08.04	Control Word Timeout Function		Default setting	0
	Range	[0]	Off	No function.
		[1]	Freeze Output	Freeze output until communication resumes.
		[2]	Stop	Stop with auto restart when communication resumes.
		[3]	Jogging	Run motor at jog frequency until communication resumes.
		[4]	Max. Speed	Run motor at max. frequency until communication resumes.
		[5]	Stop and Trip	Stop motor, then reset frequency converter in order to restart either via LCP or digital input.

- **Function:** Select the action to be taken in case of a timeout.

C08.06	Reset Control Word Timeout		Default setting	0
	Range	[0]	No Function	Control word timeout is not reset.
		[1]	Do Reset	Control word timeout is reset, and parameter goes into No Function state.

- **Function:** Resetting the control word timeout will remove any timeout function.

8-3* FC Port Settings

Parameters for configuring the FC Port.

C08.30	Protocol		Default setting	0
	Range	[0]	FC	
		[1]	MODBUS	

- **Function:** Select the protocol to be used. Note that changing protocol will not be effective until after powering off the frequency converter.

C08.31	Address	Default setting	1
	Range	[1 - 126]	

- **Function:** Select the address for the bus.
FC -bus range is 1-126.
Modbus range is 1-247.

C08.32	FC Port Baud Rate	Default setting	2
	Range	[0]	2400 Baud
		[1]	4800 Baud
		[2]	9600 Baud
		[3]	19200 Baud
		[4]	38400 Baud

- **Function:** Select baud rate for FC Port.
- **ATTENTION!** Changing baud rate will be effective after responding to any ongoing bus-requests.

C08.33	FC Port Parity	Default setting	0
	Range	[0]	Even Parity(1 stopbit)
		[1]	Odd parity
		[2]	No Parity (1 stopbit) Select this for Modbus RTU
		[3]	No Parity (2 stopbit)

- **Function:** This parameter only affects Modbus as FC bus always has even parity.

C08.35	Minimum Response Delay	Default setting	0.010s
	Range	[0.001 -0. 500 s]	

- **Function:** Specify minimum delay time between receiving a request and transmitting a response.

C08.36	Max Response Delay	Default setting	5.000s
	Range	[0.010 - 10.000 s]	

- **Function:** Specify maximum permissible delay time between transmitting a request and receiving a response. Exceeding this time delay causes control word timeout.

8-5* Digital/Bus

Parameters for configuring control word Digital/Bus merging.

ATTENTION! Parameters are only active when par. C08.01, Control SItE, is set to Digital and control word [0].

C08.50	Coasting Select		Default setting	3
	Range	[0]	Digital Input	Activation via a digital input.
		[1]	Bus	Activation via serial communication port.
		[2]	LogicAnd	Activation via serial communication port and a digital input.
		[3]	LogicOr	Activation via serial communication port or a digital input.

- **Function:** Select control of coasting function via digital input and/or bus.

C08.51	Quick Stop Select		Default setting	3
	Range	[0]	Digital Input	Activation via a digital input.
		[1]	Bus	Activation via serial communication port.
		[2]	LogicAnd	Activation via serial communication port and a digital input.
		[3]	LogicOr	Activation via serial communication port or a digital input.

- **Function:** Select control of quick stop function via digital input and/or bus.

C08.52	DC Brake Select		Default setting	3
	Range	[0]	Digital Input	Activation via a digital input.
		[1]	Bus	Activation via serial communication port.
		[2]	LogicAnd	Activation via serial communication port and a digital input.
		[3]	LogicOr	Activation via serial communication port or a digital input.

- **Function:** Select control of DC brake via digital input and/or bus.

C08.53	Start Select		Default setting	3
	Range	[0]	Digital Input	Activation via a digital input.
		[1]	Bus	Activation via serial communication port.
		[2]	LogicAnd	Activation via serial communication port and a digital input.
		[3]	LogicOr	Activation via serial communication port or a digital input.

- **Function:** Select control of start function via digital input and/or bus.

C08.54	Reversing Select		Default setting	3
	Range	[0]	Digital Input	Activation via a digital input.
		[1]	Bus	Activation via serial communication port.
		[2]	LogicAnd	Activation via serial communication port and a digital input.
		[3]	LogicOr	Activation via serial communication port or a digital input.

- **Function:** Select control of reversing function via digital input and/or bus.

C08.55	Set-up Select		Default setting	3
	Range	[0]	Digital Input	Activation via a digital input.
		[1]	Bus	Activation via serial communication port.
		[2]	LogicAnd	Activation via serial communication port and a digital input.
		[3]	LogicOr	Activation via serial communication port or a digital input.

- **Function:** Select control of set-up selection via digital input and/or bus.

C08.56	Preset Reference Select		Default setting	3
	Range	[0]	Digital Input	Activation via a digital input.
		[1]	Bus	Activation via serial communication port.
		[2]	LogicAnd	Activation via serial communication port and a digital input.
		[3]	LogicOr	Activation via serial communication port or a digital input.

- **Function:** Select control of Preset Reference selection via digital input and/or bus.

8-9* Bus Feedback

Parameter for configuring bus feedback.

C08.94	Bus feedback 1		Default setting	0
	Range	0* [0x8000 - 0x7FFF]		

Parameter group 14: Special Functions

Parameter group for configuring special frequency converter functions.

14-0* Inverter Switching

Parameters for configuring the inverter switching.

C14.01	Switching Frequency		Default setting	1
	Range	[0]	2 KHZ	
		[1]	4KHZ	
		[2]	8KHZ	
		[4]	16KHZ	

- **Function:** Select the switching frequency in order to minimize e.g. acoustic noise and power loss or maximizing efficiency.

C14.03	Overmodulation		Default setting	1
	Range	[0]	Off	Disables the overmodulation function to avoid torque ripple on the motor shaft.
		[1]	On	Connects the overmodulation function to obtain an output voltage up to 15% greater than mains voltage.

- Function:** This feature allows more accurate speed control near and over nominal speed (50/60 Hz). Another advantage with overmodulation is the ability of staying at a constant speed even though mains is dropping.

14-1* Mains Monitoring

This parameter group supplies functions for handling imbalance on mains.

C14.12	Function at mains imbalance		Default setting	0
	Range	[0]	Trip	Frequency converter trips
		[1]	Warning	Frequency converter issues a warning.
		[2]	Disabled	No action taken.

- Function:** Operation under severe mains imbalance conditions reduces drive lift time.
 Select function to take place when severe mains imbalance is detected.

14-2* Trip Reset

Parameters for configuring auto reset handling, special trip handling and control card self test or initialisation.

C14.20	Reset Mode		Default setting	0
	Range	[0]	Manual Reset	Perform reset via [reset]-button or digital inputs.
		[1]	AutoReset 1	Performs one automatic reset after tripping.
		[2]	AutoReset 2	Performs two automatic resets after tripping.
		[3]	AutoReset 3	Performs three automatic resets after tripping.
		[4]	AutoReset 4	Performs four automatic resets after tripping.
		[5]	AutoReset 5	Performs five automatic resets after tripping.
		[6]	AutoReset 6	Performs six automatic resets after tripping.
		[7]	AutoReset 7	Performs seven automatic resets after tripping.
		[8]	AutoReset 8	Performs eight automatic resets after tripping.
		[9]	AutoReset 9	Performs nine automatic resets after tripping.
		[10]	AutoReset 10	Performs ten automatic resets after tripping.
		[11]	AutoReset 15	Performs fifteen automatic resets after tripping.
		[12]	AutoReset 20	Performs twenty automatic resets after tripping.
		[13]	Infinite auto reset	Performs an infinite number of automatic resets after tripping.

- **Function:** Select reset function after tripping. Once reset, frequency converter can be restarted.
- **warning:** Motor may start without warning.

C14.21	Automatic Restart Time	Default setting	10S
	Range	[0 - 600 s]	

- **Function:** Enter time interval from trip to start of automatic reset function.
This parameter is active when par. 14-20, Reset Mode, is set to Automatic Reset [0] - [13].

C14.22	Operation Mode	Default setting	0
	Range	[0]	Normal Operation Frequency converter runs normal operation.
		[2]	Initialization Resets all parameters to default settings, except for C15.03, C15.04 and C15.05. Frequency converter resets during next power-up. Par. 14-22 also reverts to default setting Normal Operation [0].

- **Function:** Use this parameter for specifying normal operation or to initialize all parameters, except par. C15.03, C15.04 and C15.05.

C14.26	Action At Inverter Fault	Default setting	0
	Range	[0]	Trip
		[1]	Warning

C14.41	AEO Minimum Magnetisation	Default setting	66%
	Range	[40 - 75%]	

- **Function:** Enter the minimum allowable magnetization for AEO. Selecting a low value reduces energy loss in the motor, but may also reduce resistance to sudden load changes.

Parameter group 15: Drive Information

Parameter group containing information on operating data, hardware configuration, software version, etc.

15-0* Operating Data

Parameter group containing operating data e.g. Operating Hours, kWh counters, Power Ups, etc.

C15.00	Operating Time	Default setting	0
	Range	[0 - 65535 days]	

- **Function:** View running hours of frequency converter.
The value is saved at power off and cannot be reset.

C15.01	Running Hours	Default setting	0
	Range	[0 - 2147483647]	

- **Function:** View power consumption in kWh as a mean value over one hour.
Reset counter in par. C15.06, Reset kWh Counter.

C15.02	kWh Counter	Default setting	0
	Range	[0 - 65535]	

- **Function:** View power consumption in kWh as a mean value over one hour.
Reset counter in par. C15.06, Reset kWh Counter.

C15.03	Power Ups	Default setting	0
	Range	[0 - 2147483647]	

- **Function:** View number of times frequency converter has been powered up.
Counter cannot be reset.

C15.04	Over Temps	Default setting	0
	Range	[0 - 65535]	

- **Function:** View number of times frequency converter has tripped due to over temperature.
Counter cannot be reset.

C15.05	Over Volts	Default setting	0
	Range	[0 - 65535]	

- **Function:** View number of times frequency converter has tripped due to over voltage.
Counter cannot be reset.

C15.06	Reset kWh Counter	Default setting	0
	Range	[0]	Do Not Reset Counter is not reset.
		[1]	Reset Counter Counter is reset.

- **Function:** This parameter cannot be selected via serial port RS 485.

C15.07	Reset Running Hours Counter	Default setting	0
	Range	[0]	Do Not Reset Counter is not reset.
		[1]	Reset Counter Counter is reset.

- **Function:** This parameter cannot be selected via serial port RS 485.

15-3* Fault Log

This parameter group contains a fault log showing reasons for the ten latest trips.

C15.30	Fault Log: Error Code	Default setting	0
	Range	[0 - 255]	

- **Function:** View error code and look it up in VLT Micro Design Guide.

C15.4* Drive Identification

Parameters containing read only information about the hardware and software configuration of the frequency converter.

C15.40	FC Type	Default setting	**
	View FC type.		

C15.41	Power Section	Default setting	**
	View power section of frequency converter.		

C15.42	Voltage	Default setting	**
	View voltage of frequency converter.		

C15.43	Software Version	Default setting	**
	View software version of frequency converter.		

C15.46	Frequency Converter Order. No	Default setting	**
	View ordering number for re-ordering frequency converter in its original configuration.		

C15.48	LCP ID No	Default setting	**
	View LCP ID number.		

C15.51	Frequency Converter Serial No	Default setting	**
	View frequency converter serial number.		

Parameter group 16: Data Readouts

Parameter group for data read-outs, e.g. actual references, voltages, control, alarm, warning and status words.

16-0* General Status

Parameters for reading the general status, e.g. the calculated reference, the active control word, status.

C16.00	Control Word	Default setting	0
	Range	[0 - 65535]	

- **Function:** View latest valid control word sent to frequency converter via serial communication port.

C16.01	Reference [Unit]	Default setting	0.000
	Range	[-4999.000 -4999.000]	

- **Function:** View total remote reference. Total reference is sum of pulse, analog, preset, LCP potmeter, local bus and freeze reference.

C16.02	Reference %	Default setting	0.0
	Range	[-200.0 - 200.0%]	

- **Function:** View total remote reference in percent. Total reference is sum of pulse, analog, preset, LCP potmeter, local bus and freeze reference.

C16.03	Status Word	Default setting	0
	Range	[0 - 65535]	

- **Function:** View status word sent to frequency converter via serial communication port.

C16.05	Main Actual Value [%]	Default setting	0.00
	Range	[-100.00 - 100.00%]	

- **Function:** View two-byte word sent with status word to bus Master reporting main actual value.

16-1* Motor Status

C16.09	Custom Readout	Default setting	0.00
	Range	[0.00 – 9999.00%]	

- **Function:** Customized readout based on the setting of par.C0.32 and par.C4.14.

C16.10	Power [kW]	Default setting	0kw
	Range	[0 - 99 kW]	

- **Function:** View output power in kW.

C16.11	Power [hp]	Default setting	0 H p
	Range	[0 - 99 Hp]	

- **Function:** View output power inHp.

C16.12	Motor Voltage	Default setting	0.0
	Range	[0.0 - 999.9 V]	

- **Function:** View motor phase voltage.

C16.13	Frequency	Default setting	0.0HZ
	Range	[0.0 - 400.0 Hz]	

- **Function:** View output frequency in Hz.

C16.14	Motor Current	Default setting	0.00A
	Range	[0.00 - 1856.00 A]	

- **Function:** View motor phase current.

C16.15	Frequency [%]	Default setting	0.00
	Range	[-100.00 - 100.00%]	

- **Function:** View a two-byte word reporting actual motor frequency as a percentage of par. X-XX

C16.18	Motor Thermal	Default setting	0%
	Range	[0 - 100%]	

- **Function:** View calculated thermal motor load as percentage of estimated thermal motor load.

16-3* Drive Status

Parameters for reporting the status of the frequency converter.

C16.30	DC Link Voltage	Default setting	0
	Range	[0 - 10000 V]	

- **Function:** View DC-link voltage.

C16.34	Heat sink Temp.	Default setting	0
	Range	[0-255°C]	

- **Function:** View heat sink temperature of frequency converter.

C16.35	Inverter Thermal	Default setting	0%
	Range	[0-100%]	

- **Function:** View calculated thermal load on frequency converter in relation to estimated thermal load on frequency converter.

C16.36	Inv. Nom. Current	Default setting	0.00A
	Range	[0.01 - 10000.00 A]	

- **Function:** View continuous nominal inverter current.

C16.37	Inv. Max. Current	Default setting	0.00A
	Range	[0.1 - 10000.00 A]	

- **Function:** View intermittent maximum inverter current (150%).

C16.5* Ref. & Feedb.

Parameters for reporting the reference and feedback input.

C16.50	External Reference	Default setting	0.0%
	Range	[-200.0 - 200.0%]	

- **Function:** View sum of all external references in percent.

C16.51	Pulse Reference	Default setting	0.0%
	Range	[-200.0 - 200.0%]	

- **Function:** View actual pulse input converted to a reference in percent.

C16.52	Feedback [Unit]	Default setting	0.000
	Range	[-4999.000 - 4999.000]	

- **Function:** View analog or pulse feedback in Hz.

16-6* Inputs and Outputs

Parameters for reporting the digital and analog IO ports.

C16.60	Digital Input RUN,F/R,RST,EMS	Default setting	0
	Range	[0 - 1111]	

- **Function:** View signal states from active digital inputs.

C16.61	Digital Input JOG	Default setting	0
	Range	[0 - 1]	

- **Function:** View signal state on Digital Input JOG.

C16.62	Analog Input VIN (volt)	Default setting	0.00
	Range	[0.00 - 10.00 V]	

- **Function:** View input voltage on analog input terminal.

C16.63	Analog Input VIN (current)	Default setting	0.00
	Range	[0.00 - 20.00 mA]	

- **Function:** View input current on analog input terminal.

C16.64	Analog Input AIN	Default setting	0.00
	Range	[0.00 - 20.00 mA]	

- **Function:** View actual value at Input AIN either as reference or protection value.

C16.65	Analog Output AON [mA]	Default setting	0.00
	Range	[0.00 - 20.00 mA]	

- **Function:** View output current on analog Output AO.

C16.68	Pulse Input	Default setting	0Hz
	Range	[20 - 5000 Hz]	

- **Function:** View input frequency on pulse input terminal.

C16.71	Relay Output [bin]	Default setting	0
	Range	[0 - 1]	

- **Function:** View relay setting.

C16.72	Counter A	Default setting	0
	Range	[-2147483648 -2147483647]	

- **Function:** View present value of Counter A.

C16.73	Counter B	Default setting	0
	Range	[-2147483648 -2147483647]	

- **Function:** View present value of Counter B.

16-8* FC Port

Parameter for viewing references from FC Port.

C16.86	FC Port REF 1	Default setting	0
	Range	[-200 - 200]	

- **Function:** View currently received reference from FC Port.

16-9* Diagnosis Read-Out

Parameters displaying alarm, warning and extended status words.

C16.90	Alarm Word	Default setting	0
	Range	[0 - 0xFFFFFFFF]	

- **Function:** View alarm word sent via serial communication port in hex code.

C16.92	Warning Word	Default setting	0
	Range	[0 - 0xFFFFFFFF]	

- **Function:** View warning word sent via serial communication port in hex code.

C16.94	Ext. Status Word	Default setting	0
	Range	[0 - 0xFFFFFFFF]	

- **Function:** View extended warning word sent via serial communication port in hex code.

X. Maintenance, Fault Information and Troubleshooting

Periodical maintenances and inspections will keep your inverter in its normal state for long time.

1. Precautions about Inspection and Maintenance

- Be sure to turn off the power supply to the inverter (R. S. T) first before the inspection and maintenance.
- After confirming the main circuit power supply has been turned off and the display has disappeared, wait until the internal indicator lamp for high voltage goes out before performing the inspection and maintenance.
- During the inspection, do not pull out or wrongly distribute the internal power supply, wires and cables. Otherwise it will cause malfunction or damage to the inverter.
- Do not leave any screw or other part inside the inverter during the installation, or it will result in the short circuit of circuit board.
- Keep the inverter clean, free from dust, oil mist and moisture after the installation.

2. Periodical Inspection and Maintenance items

- Check whether the power supply voltage conforms to the rated voltage of the inverter.
(Pay special attention to that whether there is any damage on the power supply wires and the motor.)
- Check whether the wiring terminals and the connectors are tight
(Check whether the power supply wires and terminal connection wires have any broken strand).
- Check whether there is dust, iron filings or corrosive fluid in the inverter.
- Measuring the insulation impedance of the inverter is forbidden.
- Examine the output voltage, output current and output frequency of the inverter.
(The measuring results should not have too big difference.)
- Check whether the ambient temperature of the inverter is between -5°C and 40°C and whether the installation environment has good ventilation.
- Check whether the humidity is kept between 5% and 90% (without condensation).



- Check whether the motor makes unusual noises or abnormal vibration in running.
(The inverter should not be installed in a place with high vibration.)
- Please make periodical cleaning of vent holes.







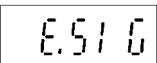

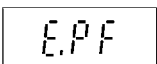
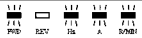
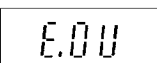
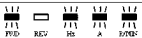
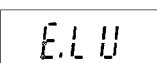
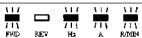
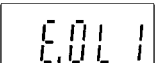
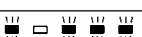
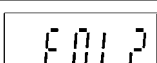
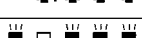
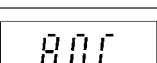
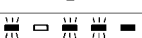

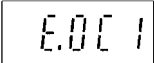
3. Fault Indication and Troubleshooting

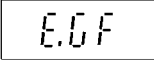

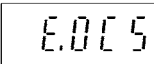

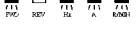
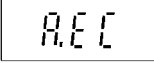

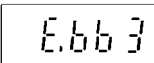
The inverter of HLP-NV series is relatively perfective with the protection functions of overload, inter-phase short circuit, earth short circuit, under-voltage, overheating and over-current, etc. When a protection function happens with the inverter please check the reasons of faults according to the information listed in the table below. The inverter can be restarted after the disposal. If the fault cannot be disposed please contact the local distributor.

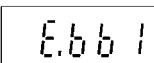
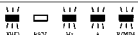

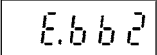

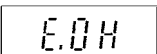
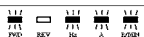
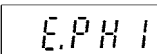
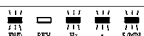
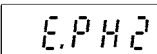
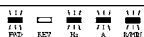
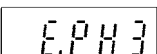
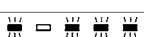
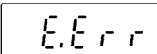

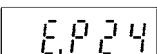
Fault	Process method
1. Motor runs unsteadily	Motor runs unsteadily but not warnings issued, please check the settings of motor parameter, if no effect, please contact holip.
2. Motor cannot rotate	Make sure no warning or alarm occurred. If any warning or alarm occurred, please refer to corresponding troubleshooting section. If no warning or alarm occurred, please refer to item 5. Please make sure if input voltage is correct and refer to item 4 if it is correct.
3. Braking function cannot take effect	Please refer to braking function section
4. No fault message or displayed	Make sure the fuse is not broken Make sure the control card is not overloaded, and it is overloaded or 24V is shorted, please remove the connection of control terminal. Make sure if any fault message is displayed, and if no, please contact Holip
5. Motor cannot rotate and no fault message displayed	Press [ENTER] key on LCP and make sure the screen is active, i.e. the display can be switched or parameter can be edited. Please make sure if the screened cable used and connected correctly. If display is no problem, please make sure the connection between motor and the drive is correct and then operate the drive in hand mode. Please contact Holip if motor cannot rotate.

4. Fault code description and Analysis

Fault Display	Fault Contents & Description	Disposal methods
 	Live zero error	Signal on terminal VIN or AIN is less than 50% of value set in par. C6.10, C6.12 and C6.22
 	Mains phase loss	Missing phase on supply side, or too high voltage imbalance. Check supply voltage.
 	DC over voltage	Intermediate circuit voltage exceeds limit.
 	DC under voltage	Intermediate circuit voltage drops below "voltage warning low" limit.
 	Inverter overloaded	More than 100% overload for too long.
 	Motor ETR over temperature	Motor is too hot due to more than 100% overload for too long.
 	Torque limit	Torque exceeds value set in either par. C4.16 or C4.17.

Fault Display	Fault Contents & Description	Disposal methods
 	Over Current	Inverter peak current limit is exceeded.
 	Earth fault	Discharge from output phases to ground.
 	Short Circuit	Short-circuit in motor or on motor terminals.
 	Control word timeout	No communication to frequency converter
 		
 	Brake resistor short-circuited	Brake transistor is short-circuited, thus brake function is disconnected.
 	Brake chopper short-circuited	Brake transistor is short-circuited, thus brake function is disconnected.

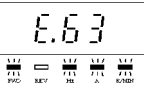
Fault Display	Fault Contents & Description	Disposal methods
 	Brake check	Brake resistor is not connected/ working
 	Power board over temp	Heat-sink cut-out temperature has been reached.
 	Motor phase U missing	Motor phase U is missing. Check the phase.
 	Motor phase V missing	Motor phase V is missing. Check the phase.
 	Motor phase W missing	Motor phase W is missing. Check the phase.
 	Internal fault	Contact local HOLIP supplier.
 	24 V supply low	External 24 V DC back-up power supply may be overloaded.

Fault Display	Fault Contents & Description	Disposal methods
	AMT check Unom and Inom	Wrong setting for motor voltage and/or motor current.
	AMT low Inom	Motor current is too low. Check settings.
	Motor thermistor over temperature	Thermistor or thermistor connection is disconnected
		
	Mechanical Brake Low	Actual motor current has not exceeded “release brake” current within “start delay” time window
	Drive Initialised to Default Value	All parameter settings are initialized to default settings.

Note: A=Alarm E=Warning

IX. Appendices

Appendix 1: Mounting Dimensions of HOLIP NV inverters

1) Mechanical drawing

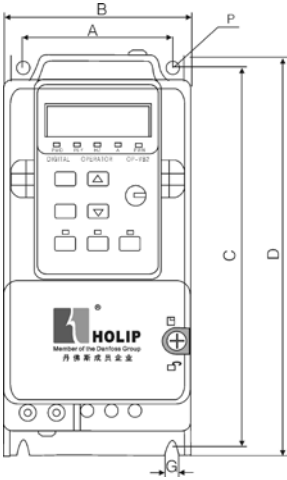
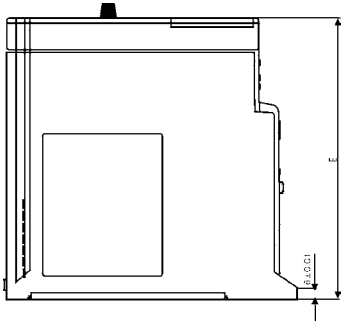
Inverter Model	Appearance and Installation Dimensions
HLPNV0D1821A	
HLPNV0D3721A	
HLPNV0D7521A	
HLPNV01D521A	
HLPNV02D221A	
HLPNV0D2523A	
HLPNV0D3723A	
HLPNV0D7523A	
HLPNV01D523A	
HLPNV02D223A	
HLPNV03D723A	
HLPNV0D3743A	
HLPNV0D7543A	
HLPNV01D543A	
HLPNV02D243A	
HLPNV03D043A	
HLPNV04D043A	
HLPNV05D543A	
HLPNV07D543A	
HLPNV001143A	
HLPNV001543A	
HLPNV18D543A	
HLPNV002243A	
	

2):External Dimensions Table (Unit: mm)

Frame	Model	A	B	C	D	E	F	G
NV1	HLPNV0D1821A	56	70	151	160	150	Φ4.5	Φ4.5
	HLPNV0D2523A							
	HLPNV0D3721A							
	HLPNV0D3723A							
	HLPNV0D3743A							
	HLPNV0D7521A							
	HLPNV0D7523A							
	HLPNV0D7543A							
NV2	HLPNV01D521A	61	75	178	186	170	Φ4.5	Φ4.5
	HLPNV01D523A							
	HLPNV01D543A							
	HLPNV02D243A							
NV3	HLPNV02D221A	76	90	230	239	196	Φ4.5	Φ4.5
	HLPNV02D223A							
	HLPNV03D043A							
	HLPNV03D723A							
	HLPNV04D043A							
	HLPNV05D543A							
	HLPNV07D543A							
NV4	HLPNV001143A	97	125	273	292	243	Φ7	Φ7
	HLPNV001543A							
NV5	HLPNV18D543A	137	165	316	335	252	Φ7	Φ7
	HLPNV002243A							

Note: Type NV2, NV3, NV4, NV5 are embedded with brake unit but NV1 without brake unit.

Appendix 2: Mounting Dimensions of LCP Digital operator

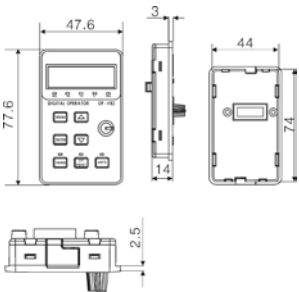
Inverter Model	Appearance and Installation Dimensions(Unit:mm)
HOLIP-NV LCP operator	

Appendix 3. Braking Resistor Disposition

200-240V

Model (KW)	Braking resistor Specification		Braking torque 40%ED	Suitable Motor(KW)
	KW	Ω		
1.5	0.8	65	1.6	1.5
2.2	1	50	1.6	2.2
3.7	3	25	1.6	3.7

380-440V

Model (KW)	Braking resistor Specification		Braking torque 40%ED	Suitable Motor(KW)
	KW	Ω		
1.5	0.8	310	1.6	1.5
2.2	1.35	210	1.6	2.2
3.0	2	150	1.6	3.0
4.0	2.4	110	1.6	4.0
5.5	3	80	1.6	5.5
7.5	4.5	65	1.6	7.5
11	5	40	1.6	11
15	9.3	30	1.6	15
18.5	12.7	25	1.6	18.5
22	13	20	1.6	22

Appendix 4. Simple Example of Application

1: Parameter Initialization

C14.22 used to reset parameter to default settings

- Set C14.22 = 2
 - Hold down“ENTER”to confirm changing
 - Cut off mains
 - Resart the drive.
- E80 was displayed to indicate the completion of the process
- Press“Off/Reset”key to confirm the operation.

2: Use LCP to control the drive

1. Press “Hand” key
2. Reference source: Potentiometer or arrow keys
(for LCP without pot.).

3: Use extern terminals to control the drive

1. Press AUTO key (Digital control and communication control are active only in Auto mode)
2. Connect RUN with EV to operate the drive (terminal RUN was set to “RUN”function)
3. Analogue input VI, AI or the pot. On LCP can be used to set reference.

4: AMT sequence (Automatic motor tuning)

1. Stop the drive and make sure motor is at standstill
 2. Enter motor nameplate data to C01.20 to C01.25 .
 3. choose [2] of C01.29 to enable AMT.
 4. Apply start signal: press “Hand”via LCP or Apply start signal in Auto mode, - AT – will be displayed
 5. AMT completed till “PUSH ENT” was displayed
- Note: AMT dose not need to rotate motor.

5:Speed UP/ Down(UP DOWN)

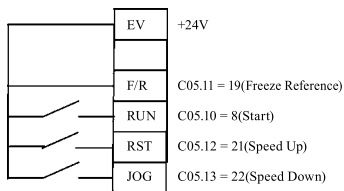

Use terminals of RST and EMS to realize:

C05.11 = 19

C05.10 = 8

C05.12 = 21

C05.13 = 22

Press "Auto" key to active Auto mode

6: Multi-speed (eight speed at most)

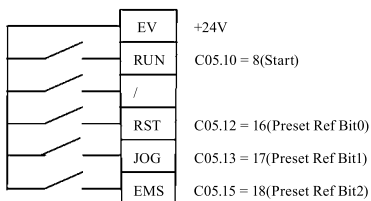

Use terminals of RST,JOG,EMS to select preset reference

C05.10 = 8(Start)

C05.12 = 16(Preset Ref Bit0)

C05.13 = 17(Preset Ref Bit1)

C05.15 = 18(Preset Ref Bit2)

C03.02 = 0(Min reference)

C03.03 = 50(Max reference)

C03.10[0] = xx //Spped 1

C03.10[1] = xx // Spped 2

C03.10[2] = xx // Spped 3

C03.10[3] = xx // Spped 4

C03.10[4] = xx // Spped 5

C03.10[5] = xx // Spped 6

C03.10[6] = xx // Spped 7

C03.10[7] = xx // Spped 8

Press "Auto" key to active Auto mode

Speed select table (0: OFF 1: ON)

Speed	EMS	JOG	RST
Speed 1	0	0	0
Speed 2	0	0	1
Speed 3	0	1	0
Speed 4	0	1	1
Speed 5	1	0	0
Speed 6	1	0	1
Speed 7	1	1	0
Speed 8	1	1	1

7: Process close loop control (PI control)

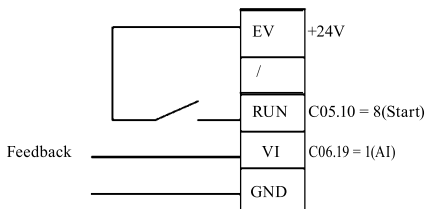

C01.00 = 3

setpoint:

C03.15, C03.16, C03.17, C03.14, C03.18 defines the setpoint of PI control

feedback:

C07.20 defines the feedback signal of PI control

Example: Use preset reference C03.10(0) as setpoint,

Use 4-20mA Analogue input as feedback

Parameters setting

C03.02 = 0 C03.03 = 50 C03.10(0) = 50%

C03.15 = C03.16 = C03.17 = C03.14 = C03.18 = 0

C06.12 = 4mA C06.13 = 20mA C06.14 = 0 C06.15 = 50 C06.19 = 1

C07.20 = 1(VI) C07.30 = 0 C07.31 = 0 C07.32 = 0

C07.33 = 1.00 C07.34 = 10.00s C07.38 = 0 C07.39 = 50%

Trun on switch 4

Press "**Auto**" to active Auto mode

Connect RUN with EV to operate the drive.

8: Pulse input

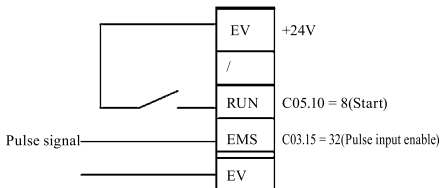

C03.15 = 8 Pulse input select
 C03.16 = 0
 C03.17 = 0
 C05.10 = 8 Start command
 C05.15 = 32 Pulse input select
 C05.55 = 20 Terminal EMS low frequency
 C05.56 = 5000 Terminal EMS high frequency
 C05.57 = 0 Terminal EMS low value
 C05.58 = 50 Terminal EMS high value
 C16.68 can be Viewew input frequency on EMS
 Press "Auto" to active Auto mode
 Connect RUN with EV to operate the drive.

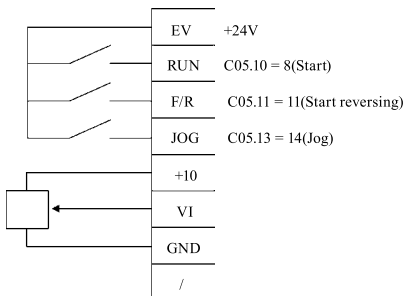

C03.11 = 10.00Hz(Jog frequency)
 C03.15 = 1 C03.16 = 0 C03.17 = 0
 C03.41 = 0.5S C03.42 = 0.5S C03.80 = 0.5
 C04.10 = 2
 C05.10 = 8 C05.11 = 11
 C05.13 = 14
 C06.10 = 0V C06.11 = 10V
 C06.14 = 0Hz C06.15 = 50Hz

Press "Auto" to active Auto mode
Connect RUN with EV to operate the drive.
Connect F/R with EV to operate the drive

10:V/F and VVC+**1: V/F**

C01.01 = 0 V/F principle

C01.55 (0) (1) (2) (3) (4) (5) -- Voltage setting of V/F characteristic
10 55 380 380 380 380

C01.56 (0) (1) (2) (3) (4) (5) -- Voltage setting of V/F characteristic
0 5 50 50 50 50

2:VVC+

C01.01 = 1 VVC+ principle

C01.20 Motor Power C01.22 Motor Voltage

C01.23 Motor Frequency

C01.23 Motor Current C01.25 Motor Nominal Speed

C01.29 Automatic Motor Tuning

C01.30 Stator Resistance C01.33 Stator Leakage Reactance

C01.35 Main Reactance

C01.60 Low Speed Load Compensation

C01.61 High Speed Load Compensation

C01.62 Slip Compensation C01.63 Slip Compensation

Use AMT to optimize motor performance in VVC+ principle

11: How to display motor speed

Example: Motor 1440/min, 50HZ

C00.31=0 , C00.32=1440

C04.14=50HZ

The custom readout will be the motor speed

12: Use LCP Pot. to realize running forward/reverse (LCP:OP-VB02)

Example: Turn the pot. clockwise from "zero" position, reference changes from -50 to 50(reverse 50HZ—0HZ—forward50HZ)

C3.00 = 1 C3.15 = 0 C3.16 = 0 C3.17 = 21

C06.81= -50 C06.82 = 50

Press "Auto" to active Auto mode

Connect RUN with EV to operate the drive.

Note: In "HAND" mode, reference can only be adjusted from 0 to maximum setting using LCP pot..

13:Use arrow keys to realize running forward/reverse in "HAND"

mode (LCP: OP-VB03)

C3.00 = 1

Press "Hand" to active hand mode

Press "∧" key, reference increase to maximum reference

Press "∨" key, reference decrease to -maximum reference

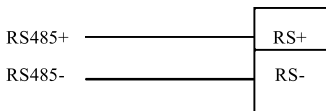
14:Communication examples

FC-protocol

C08.32 = 9600bps C08.33 = 0

14.1 Start with the reference of 50HZ Send:

```

STX LGE ADR CTW REF CS
02 06 01 047C 4000 3D (Hex)
  
```

(the frequency converter) Return:

```

STX LGE ADR STW REF CS
02 06 01 0F07 4000 4D (Hex)
  
```

047C : Command

4000 : 50Hz

(C000H – 4000H corresponding to –MAX ---- +MAX)

14.2 Stop with the reference of 0HZ Send:

```

STX LGE ADR CTW REF CS
02 06 01 043C 0000 3D (Hex)
  
```

(the frequency converter) Return:

```

STX LGE ADR STW REF CS
02 06 01 0203 0000 04 (Hex)
  
```

14.3 Read parameter C03.41 Send:

```

STX LGE ADR DATA -----DATA CTW REF CS
02 0E 01 1115 0000 0000 0000 0000 0000 49 (Hex)
  
```

(the frequency converter)Return:

```

STX LGE ADR DATA -----DATA STW REF CS
02 0E 01 2155 0000 0000 012C 0203 0000 55 (Hex)
  
```

14.4 Write parameter C03.41 Send:

```

STX LGE ADR DATA -----DATA CTW REF CS
02 0E 01 D115 0000 0000 0190 0000 0000 18 (Hex)
  
```

(the frequency converter)Return:

```

STX LGE ADR DATA -----DATA STW REF CS
02 0E 01 2155 0000 0000 0190 0203 0000 E9 (Hex)
  
```

MODBUS

14.5 Read coils ----- Read status

Read reference frequency:

TX: 01 01 0010 0010 3C03
RX: 01 01 02 333C AD1D

3C33 means 47.03Hz

Read status word: (47.03Hz Run)

TX: 01 01 0020 0010 3C0C
RX: 01 01 02 070D 7A09

12.6: Read holding registers ---Read the value of parameters

Read C03.41 Address: $341*10 - 1 = 3409 = 0D51H$

TX: 01 03 0D51 0002 9776

RX: 01 03 04 00000190 FBCF

00000190 = 400 (4.00S)

Read C05.11 Address: $511*10 - 1 = 5109 = 13F5H$

TX: 01 03 13F5 0001 90BC

RX: 01 03 02 000A 3843

12.7: Write single coils --- Control Word

Write the value of parameter to RAM and EEPROM

TX: 01 05 0040 FF00 8DEE

RX: 01 05 0040 FF00 8DEE

12.8: Write single register ---Write parameter(Single Word)

Write C05.11 Address: $511*10 - 1 = 5109 = 13F5H$

TX: 01 06 13F5 000B DCBB

RX: 01 06 13F5 000B DCBB

12.9: Write mutiple coils ---Write control word and reference frequency

Start with the reference of 50HZ

TX: 01 0F 0000 0020 04 7C04 0040 9D29

RX: 01 0F 0000 0020 5413

12.10: Write mutiple register --- Write parameter

Write C06.15 Address: $615*10 - 1 = 6149 = 1805H$

TX: Addr01 10 1805 0002 04 0000EA60 D6D8

RX: 01 10 1805 0002 5769

Appendix 5:User's feedback

Item	Function Code	Fuction Description	Default setting	User's Par.	
Operation / Display	C00.04	Oper. State at Power-up [Hand]	1		
	C00.31	Custom Readout Min Scale	0.00		
	C00.32	Custom Readout Max Scale	100.00		
	C00.40	[Hand on] Key on LCP	1		
	C00.41	[Off / Reset] Key on LCP	1		
	C00.42	[Auto on] Key on LCP	1		
	C00.60	Menu Locked	0		
Load / Motor	C01.00	Configuration Mode	0		
	C01.01	Motor Control Principle	1		
	C01.03	Torque Characteristics	0		
	C01.05	Local Mode Configuration	2		
	C01.20	Motor Power [kW] [HP]	**		
	C01.22	Motor Voltage	**		
	C01.23	Motor Frequency	50		
	C01.24	Motor Current	**		
	C01.25	Motor Nominal Speed	**		
	C01.29	Automatic Motor Tuning (AMT)	0		
	C01.30	Stator Resistance (Rs)	**		
	C01.33	Stator Leakage Reactance (X1)	**		
	C01.35	Main Reactance (X2)	**		
	C01.50	Motor Magnetisation at 0 Speed	100%		
	C01.52	Min Speed Norm. Magnet. [Hz]	0.0H z		
	C01.55	V/F Characteristic - V	0V		
	C01.56	V/F Characteristic - F	0H z		
	C01.60	Low Speed Load Compensation	100%		
	C01.61	High Speed Load Compensation	100%		
	C01.62	Slip Compensation	100%		
	C01.63	Slip Compensation Time Constant	0.10s		
	C01.71	Start Delay	0.0S		
C01.72	Start Function	2			
C01.73	Flying Start	0			
C01.80	Function at Stop	0			
C01.82	Min Speed for Funct. at Stop [Hz]	0.0Hz			
C01.90	Motor Thermal Protection	3			
C01.93	Thermistor Resource	0			

Item	Function Code	Fuction Description	Default setting	User's Par.
Brakes	C02.00	DC Hold Current	50%	
	C02.01	DC Brake Current	50%	
	C02.02	DC Braking Time	10.0S	
	C02.04	DC Brake Cut In Speed	0.0Hz	
	C02.10	Brake Function	0	
	C02.11	Brake Resistor (ohm)	5Ω	
	C02.16	AC Brake, Max current	100%	
	C02.17	Over-voltage Control	0	
	C02.20	Release Brake Current	0.00A	
	C02.22	Activate Brake Speed [Hz]	0.0HZ	
Reference / Ramps	C03.00	Reference Range	0	
	C03.02	Minimum Reference	0.000	
	C03.03	Maximum Reference	50.000	
	C03.10	Preset Reference	0.00%	
	C03.11	Jog Speed [Hz]	5.0Hz	
	C03.12	Catch up/slow Down Value	0.00%	
	C03.14	Preset Relative Reference	0.00%	
	C03.15	Reference Resource 1	1	
	C03.16	Reference Resource 2	2	
	C03.17	Reference Resource 3	11	
	C03.18	Relative Scaling Ref. Resource	0	
	C03.40	Ramp 1 Type	0	
	C03.41	Ramp 1 Ramp up Time	3.00/15.00S	
	C03.42	Ramp 1 Ramp Down Time	3.00/30.00S	
	C03.50	Ramp 2 Type	0	
	C03.51	Ramp 2 Ramp up Time	3.00/15.00S	
	C03.52	Ramp 2 Ramp down Time	3.00/30.00S	
C03.80	Jog Ramp Time	3.00/15.00S		
C03.81	Quick Stop Ramp Time	3.00/30.00S		
Limits / Warnings	C04.10	Motor Speed Direction	2	
	C04.12	Motor Speed Low Limit [Hz]	0.0Hz	
	C04.14	Motor Speed High Limit [Hz]	65.0Hz	
	C04.16	Torque Limit Motor Mode	150%	
	C04.17	Torque Limit Generator Mode	100%	
	C04.50	Warning Current Low	0.00A	
	C04.51	Warning Current High	26.00A	
	C04.58	Missing Motor Phase Function	1	
	C04.61	Bypass Speed From [Hz]	0.0Hz	
	C04.63	Bypass Speed To [Hz]	0.0Hz	

Item	Function Code	Fuction Description	Default setting	User's Par.
Digital In / Out	C05.10	Terminal RUN Digital Input	8	
	C05.11	Terminal F/R Digital Input	10	
	C05.12	Terminal RST Digital Input	1	
	C05.13	Terminal JOG Digital Input	14	
	C05.15	Terminal EMS Digital Input	16	
	C05.40	Function Relay	9	
	C05.55	Terminal EMS Low Frequency	20	
	C05.56	Terminal EMS High Frequency	5000	
	C05.57	Term. EMS Low Ref./Feedb. Value	0.000	
	C05.58	Term. EMS High Ref./Feedb. Value	50.000	
Analog In / Out	C06.00	Live Zero Timeout Time	10S	
	C06.01	Live Zero TimeoutFunction	0	
	C06.10	Terminal VIN Low Voltage	0.07V	
	C06.11	Terminal VIN High Voltage	10.00V	
	C06.12	Terminal VIN Low Current	0.14	
	C06.13	Terminal VIN High Current	20.00	
	C06.14	Term. VIN Low Ref./Feedb. Value	0.000	
	C06.15	Term. VIN High Ref./Feedb. Value	50.000	
	C06.16	Terminal VIN Filter Time Constant	0.01	
	C06.19	Terminal VIN mode	0	
	C06.22	Terminal AIN Low Current	0.14	
	C06.23	Terminal AIN High Current	20.00	
	C06.24	Term. AIN Low Ref./Feedb. Value	0.000	
	C06.25	Term. AIN High Ref./Feedb. Value	50.000	
	C06.26	Terminal AIN Filter Time Constant	0.01	
	C06.81	LCP potm. Low Ref./Feedb. Value	0.000	
	C06.82	LCP potm. High Ref./Feedb. Value	50.000	
	C06.90	Terminal AO Mode	0	
	C06.91	Terminal AO Analog Output	10	

Item	Function Code	Fuction Description	Default setting	User's Par.
	C06.92	Terminal AO Digital Output	0	
	C06.93	Terminal AO Output Min Scale	0.00%	
	C06.94	Terminal AO Output Max Scale	100.00%	
Proess PI Controlers	C07.20	Process CL Feedback 1 Resource	0	
	C07.30	Process PI Normal/ Inverse Ctrl	0	
	C07.31	Process PI Anti Windup	1	
	C07.32	Process PI Start Speed	0.0	
	C07.33	Process PI Proportional Gain	0.01	
	C07.34	Process PI Integral Time	9999.00	
	C07.38	Process PI Feed Forward Factor	0%	
	C07.39	On Reference Bandwidth	5%	
Commu- nication	C08.01	Control Site	0	
	C08.02	Control Word Source	1	
	C08.03	Control Word Timeout Time	1.0S	
	C08.04	Control Word Timeout Function	0	
	C08.06	Reset Control Word Timeout	0	
	C08.30	Protocol	0	
	C08.31	Address	1	
	C08.32	FC Port Baud Rate	2	
	C08.33	FC Port Parity	0	
	C08.35	Minimum Response Delay	0.010S	
	C08.36	Max Response Delay	5.000S	
	C08.50	Coasting Select	3	
	C08.51	Quick Stop Select	3	
	C08.52	DC Brake Select	3	
	C08.53	Start Select	3	
	C08.54	Reversing Select	3	
	C08.55	Set-up Select	3	
C08.56	Preset Reference Select	3		
C08.94	Bus feedback 1	0		
Special Function	C14.01	Switching Frequency	1	
	C14.03	Overmodulation	1	
	C14.12	Function at mains imbalance	0	
	C14.20	Reset Mode	0	
	C14.21	Automatic Restart Time	10S	
	C14.22	Operation Mode	0	
	C14.26	Action At Inverter Fault	0	
C14.41	AEO Minimum Magnetisation	66%		

Item	Function Code	Fuction Description	Default setting	User's Par.
Drive Information	C15.00	Operating Time	0	
	C15.01	Running Hours	0	
	C15.02	kWh Counter	0	
	C15.03	Power Ups	0	
	C15.04	Over Temps	0	
	C15.05	Over Volts	0	
	C15.06	Reset kWh Counter	0	
	C15.07	Reset Running Hours Counter	0	
	C15.30	Fault Log: Error Code	0	
	C15.40	FC Type	**	
	C15.41	Power Section	**	
	C15.42	Voltage	**	
	C15.43	Software Version	**	
	C15.46	Frequency Converter Order. No	**	
	C15.48	LCP Id No	**	
C15.51	Frequency Converter Serial No	**		
Data Readouts	C16.00	Control Word	0	
	C16.01	Reference [Unit]	0.000	
	C16.02	Reference %	0.0	
	C16.03	Status Word	0	
	C16.05	Main Actual Value [%]	0.00	
	C16.09	Custom Readout	0.00	
	C16.10	Power [kW]	0KW	
	C16.11	Power [hp]	0HP	
	C16.12	Motor Voltage	0.0	
	C16.13	Frequency	0.0Hz	
	C16.14	Motor Current	0.00A	
	C16.15	Frequency [%]	0.00%	
	C16.18	Motor Thermal	0%	
	C16.30	DC Link Voltage	0	
	C16.34	Heatsink Temp	0	
	C16.35	Inverter Thermal	0%	
	C16.36	Inv. Nom. Current	0.00A	
	C16.37	Inv. Max. Current	0.00A	
C16.50	External Reference	0.0%		
C16.51	Pulse Reference	0.0%		
C16.52	Feedback [Unit]	0.000		

Item	Function Code	Fuction Description	Default setting	User's Par.
	C16.60	Digital Input RUN,F/ R,RST,EMS	0	
	C16.61	Digital Input JOG	0	
	C16.62	Analog Input VIN (volt)	0.00	
	C16.63	Analog Input VIN (current)	0.00	
	C16.64	Analog Input AIN	0.00	
	C16.65	Analog Output AO [mA]	0.00	
	C16.68	Pulse Input	20Hz	
	C16.71	Relay Output [bin]	0	
	C16.72	Counter A	0	
	C16.73	Counter B	0	
	C16.86	FC Port REF 1	0	
	C16.90	Alarm Word	0	
	C16.92	Warning Word	0	
	C16.94	Ext. Status Word	0	